

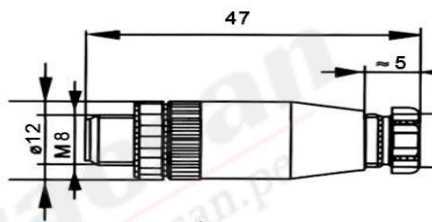

M8 系列普通型技术参数

针数	3	4	Number of contacts
锁紧方式	螺纹式/screw		Connector locking system
接线方式	螺钉压接、焊接/screw, solder		Termination
连接截面	最大0.25平方毫米/max.0.25mm ²		Wire gauge
电缆直径	3.5-5mm		Cable outlet
防护等级	IP67		Degree go protection
机械寿命	>100次插拔周期/ >100 mating cycles		Mechanical operation
工作温度	(-25° - 85°)		temperature range
额定电压	60V	30V	Rated voltage
额定冲击电压	1500V		Rated impulse voltage
污染等级	3		Pollution degree
过电保护等级	II		Overvoltage categorie
绝缘组别	III		Material group
额定电流 (40°)	3A		Rated current(40°)
接触电阻	<=3mΩ(金/gold)		Contact resistance
触点材料	黄铜/brass		Material of contact
触点电镀材料	金/gold		Contact plating
插座材料	尼龙/PA		Material of contact body
外壳材料	尼龙/PA		Material of housing



Male Size

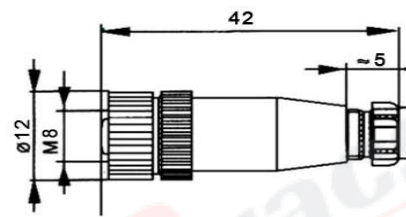

Female Size

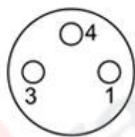
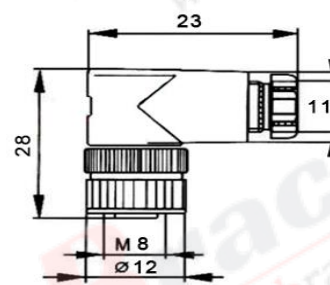
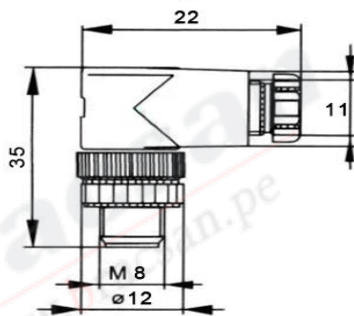

	X	Y
1	1.75	0
2	-	-
3	-1.75	0
4	0	1.75

3Pin



	X	Y
1	-1.75	0
2	-	-
3	1.75	0
4	0	1.75

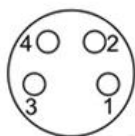

	X	Y
1	1.70	-0.50
2	1.08	1.45
3	-1.70	-0.50
4	-1.08	1.45

4Pin

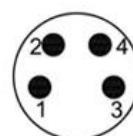

	X	Y
1	-1.70	-0.50
2	-1.08	1.45
3	1.70	-0.50
4	1.08	1.45