



M12 Male Front Mount Socket Solder PG11

PRODUCT PARAMETERS

Shell material :	Brass nickel plating / zinc alloy nickel / PA
Insulator material :	PA / TPU
Sealing material :	Epoxy resin / Rubber
Contact material :	Brass / Phosphorus copper gold-plated
Waterproof grade :	IP65 / IP67
Insulation impedance :	$\geq 100 \text{ m}\Omega$
Contact impedance :	$\leq 5 \text{ m}\Omega$
Durability :	≥ 500 Cycles
Applicable temperature :	-25°C ~ +80°C
Execution standard :	IEC 61076-2-101



M12 ELECTRICAL PARAMETERS



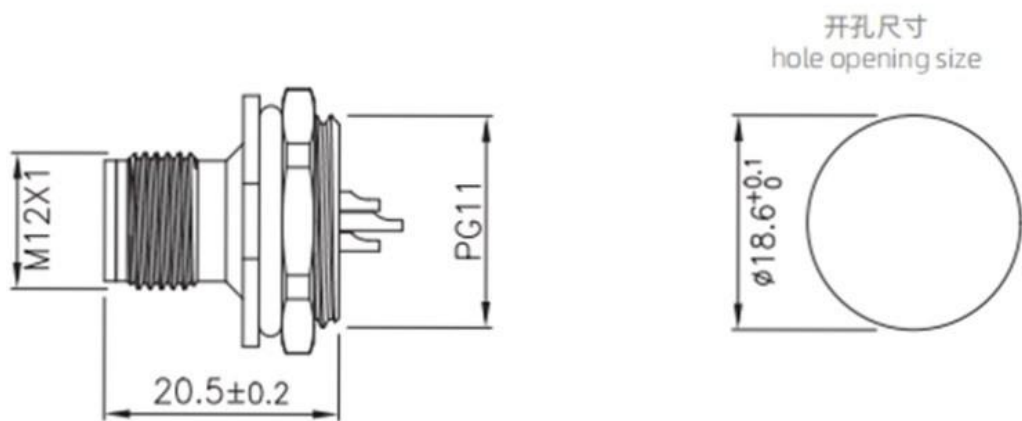

芯数 Pins	针型 Male				额定电流 Rated current	额定电压 Rated voltage		导体规格 Conductor size		孔型 Female			
	A	B	C	D		A/C	D/C	AWG	mm ²	A	B	C	D
2					4A	250V	250V	22	0.34				
3					4A	250V	250V	22	0.34				
4					4A	250V	250V	22	0.34				
5					4A:A型(A-Code) B型(B-Code) 2A:C型(C-Code)	60V	60V	22	0.34				
6					2A	30V	30V	24	0.25				
8					2A	30V	30V	24	0.25				
12					1.5A	30V	30V	26	0.14				
17					1.5A	30V	30V	26	0.14				

DIMENSION DRAWING



WIRE DEFINITION

芯位 Pins	线芯颜色 Wire core color	
	2芯(Pins)	
1	BN	
2	-	
3	BU	

芯位 Pins	线芯颜色 Wire core color	
	3芯(Pins)	
1	BN	
2	-	
3	BU	
4	BK	

芯位 Pins	线芯颜色 Wire core color	
	6芯(Pins)	
1	BN	
2	WH	
3	BU	
4	BK	
5	-	
6	GY	
7	RD	

芯位 Pins	线芯颜色 Wire core color	
	8芯(Pins)	
1	WH	
2	BN	
3	GN	
4	YE	
5	GY	
6	PK	
7	BU	
8	RD	

芯位 Pins	线芯颜色 Wire core color					
	4芯A编码(4 Pins A-Code)		4芯B编码(4 Pins B-Code)		4芯D编码(4 Pins D-Code)	
1	BN		BN		YE	
2	WH		WH		WH	
3	BU		BU		OG	
4	BK		BK		BU	

芯位 Pins	线芯颜色 Wire core color			
	5芯A编码(5 Pins A-Code)		5芯B编码(5 Pins B-Code)	
1	BN		BN	
2	WH		WH	
3	BU		BU	
4	BK		BK	
5	GY		GY	

芯位 Pins	线芯颜色 Wire core color	
	12芯(Pins)	
1	BN	
2	BU	
3	WH	
4	GN	
5	PK	
6	YE	
7	BK	
8	GY	
9	RD	
10	VT	
11	OG	
12	LTGN	

芯位 Pins	线芯颜色 Wire core color	
	17芯(Pins)	
1	BN	
2	BU	
3	WH	
4	GN	
5	PK	
6	YE	
7	BK	
8	GY	
9	RD	
10	VT	
11	OG	
12	LTGN	
13	LTBU	
14	BKWH	
15	BNWH	
16	RDWH	
17	BUWH	

*接线定义按常规标准，如按协议或者其他请联系我司业务。

Wiring definition according to conventional standards, if according to the agreement or other please contact our sales.