



ADS800A Series User Manual

- **ADS802A/804A**
- **ADS812A/814A**
- **ADS822A/824A**

For product support, visit: www.owon.com.hk/download

※: The illustrations, interface, icons and characters in the user manual may be slightly different from the actual product. Please refer to the actual product.

Nov. 2025 edition V1.0.4

Copyright © LILLIPUT Company. All rights reserved.

The LILLIPUT's products are under the protection of the patent rights, including ones which have already obtained the patent rights and those which are applying for. The information in this manual will replace all that in the materials published originally.

The information in this manual was correct at the time of printing. However, LILLIPUT will continue to improve products and reserves the rights to change specification at any time without notice.

OWON[®] is the registered trademark of the LILLIPUT Company.

Fujian LILLIPUT Optoelectronics Technology Co., Ltd.

No. 19, Heming Road

Lantian Industrial Zone, Zhangzhou 363005 P.R. China

Tel: +86-596-2130430

Fax: +86-596-2109272

Web: www.owon.com.cn

E-mail: info@owon.com.cn

General Warranty

We warrant that the product will be free from defects in materials and workmanship for a period of 3 years from the date of purchase of the product by the original purchaser from our company. The warranty period for accessories such as probes is 12 months. This warranty only applies to the original purchaser and is not transferable to a third party.

If the product proves defective during the warranty period, we will either repair the defective product without charge for parts and labour, or will provide a replacement in exchange for the defective product. Parts, modules and replacement products used by our company for warranty work may be new or reconditioned like new. All replaced parts, modules and products become the property of our company.

To obtain service under this warranty, the customer must notify our company of the defect before the expiration of the warranty period. Customer shall be responsible for packaging and shipping the defective product to our designated service centre, a copy of the customer's proof of purchase is also required.

This warranty shall not apply to any defect, failure or damage caused by improper use or improper or inadequate maintenance and care. We shall not be obligated to furnish service under this warranty a) to repair damage resulting from attempts by personnel other than our company representatives to install, repair or service the product; b) to repair damage resulting from improper use or connection to incompatible equipment; c) to repair any damage or malfunction caused by the use of not our supplies; or d) to service a product that has been modified or integrated with other products when the effect of such modification or integration increases the time or difficulty of servicing the product.

Please contact the nearest sales and service offices for services.

Excepting the after-sales services provided in this summary or the applicable warranty statements, we will not offer any guarantee for maintenance definitely declared or hinted, including but not limited to the implied guarantee for marketability and special-purpose acceptability. We should not take any responsibilities for any indirect, special or consequent damages.

Table of Contents

1. General Safety Requirements	1
2. Safety Terms And Symbols	3
How To Conduct A General Inspection	5
How To Conduct Function Inspection	6
3. Primary User Guide	7
A General Knowledge Of The Structure Of The Instrument	8
Front Panel	8
Rear Panel	10
A General Knowledge Of The User Interface Of The Instrument	11
Oscilloscope Inspection	14
How To Implement The Probe Compensation	14
How To Set The Probe Attenuation Coefficient	15
How To Use The Probe Safely	16
How To Conduct Self-Calibration	17
4. Use the Android System	18
Android System Homepage Window	18
System Built-in Application List	18
5. Use the Oscilloscope	20
A General Knowledge Of Oscilloscope	20
A General Knowledge Of Trigger System	20
A General Knowledge Of Horizontal System	20
A General Knowledge Of Vertical System	21
How To Use Touch Screen Control	23
Use The Touch Screen To Operate The Menu	23
Operate The Touch Screen	25
Operate The Touch Screen In Waveform Amplification Mode	27
Other Touch Screen Operations	28
Advanced User Guide for Oscilloscope	31
How To Set Vertical System	32
How To Set Horizontal System	37
How To Set Acquire	40
How To Set Trigger	42
Trigger Control	43
How To Set Analysis Modulation	66
How To Set Automatic Measurement	67
How To Set XY Mode	76
How To Set Cursor Measurement	77

How to Realize Waveform Operation Function	82
How To Set FFT	85
How To Set DIR(Digital Filtering)	89
How To Set Pass Fail	90
How To Set Counter	92
How To Set DVM	94
How To Set Decode	97
How To Set Waveform Record/Player	107
How To Set Others Modulation	110
How To Set Display System	110
How To Save And Print	113
How To Set Reference Waveform	127
How To Conduct Self-Calibration	129
How To Conduct Probe Check	129
How To Set Network	130
Default	134
About	135
Configuration	135
Hardware-Test	137
How To Use Execution Keys	137
6. Technical Specifications	141
Oscilloscope	141
Vertical System	141
Analog Channel	141
Horizontal System	142
Analog Channel	142
Acquire System	143
Trigger	143
Trigger System	143
Trigger Type	144
Waveform	145
Waveform Measurement	145
Waveform Analysis	146
Decode	147
Counter	148
DVM	148
Command	148
General Technical Specification	148
Display	148
Processor system	149
Output of the Probe Compensator	149
Others	149
Environment	150

Mechanical Specifications	150
7. Appendix	151
Appendix A: Accessories	151
Appendix B: General Care And Cleaning	151

1.General Safety Requirements

Before use, please read the following safety precautions to avoid any possible bodily injury and to prevent this product or any other connected products from damage. In order to avoid any contingent danger, ensure this product is only used within the range specified.

Only the qualified technicians can implement the maintenance.

To avoid Fire or Personal Injury:

- **Connect the probe correctly.** The grounding end of the probe corresponds to the grounding phase. Please don't connect the grounding end to the positive phase.
- **Use Proper Power Cord.** Use only the power cord supplied with the product and certified to use in your country.
- **Connect or Disconnect Correctly.** When the probe or test lead is connected to a voltage source, please do not connect and disconnect the probe or test lead at random.
- **Product Grounded.** This instrument is grounded through the power cord grounding conductor. To avoid electric shock, the grounding conductor must be grounded. The product must be grounded properly before any connection with its input or output terminal.

When powered by AC power, it is not allowed to measure AC power source directly, because the testing ground and power cord ground conductor are connected together, otherwise, it will cause short circuit.

- **Check all Terminal Ratings.** To avoid fire or shock hazard, check all ratings and markers of this product. Refer to the user's manual for more information about ratings before connecting to the instrument.
- **Do not operate without covers.** Do not operate the instrument with covers or panels removed.
- **Use Proper Fuse.** Use only the specified type and rating fuse for this

instrument.

- **Avoid exposed circuit.** Do not touch exposed junctions and components when the instrument is powered.
- **Do not operate if in any doubt.** If you suspect damage occurs to the instrument, have it inspected by qualified service personnel before further operations.
- **Use your Oscilloscope in a well-ventilated area.** Make sure the instrument installed with proper ventilation, refer to the user manual for more details.
- **Do not operate in wet conditions.**
- **Do not operate in an explosive atmosphere.**
- **Keep product surfaces clean and dry.**

2.Safety Terms And Symbols

Safety Terms

Terms in this manual. The following terms may appear in this manual:



Warning: Warning indicates the conditions or practices that could result in injury or loss of life.



Caution: Caution indicates the conditions or practices that could result in damage to this product or other property.

Terms on the product. The following terms may appear on this product:











Danger: It indicates an injury or hazard may immediately happen.

Warning: It indicates an injury or hazard may be accessible potentially.

Caution: It indicates a potential damage to the instrument or other property might occur.

Safety Symbols

Symbols on the product. The following symbol may appear on the product:

	Hazardous Voltage		Protective Earth Terminal
	Chassis Ground		Test Ground
	Direct current (DC)		Fuse
	Alternating current (AC)		Caution, risk of danger (refer to this manual for specific Warning or Caution information)
	Both direct and alternating current	CAT II	Category II overvoltage protection
	Conforms to European Union directives	CAT III	Category III overvoltage protection
	Equipment protected throughout by double insulation or reinforced insulation	CAT IV	Category IV overvoltage protection

To avoid body damage and prevent product and connected equipment damage, carefully read the following safety information before using the test tool. This product can only be used in the specified applications.

 **Warning:**

The four channels of the oscilloscope are not electrically isolated. The channels should adopt a common ground during measuring. To prevent short circuits, the 4 probe grounds must not be connected to 4 different non-isolated DC levels.

 **Warning:**

Note when measuring the channel to the public base, otherwise may cause short circuit because of the oscilloscope probe ground wire.

The diagram of the oscilloscope ground wire connection:

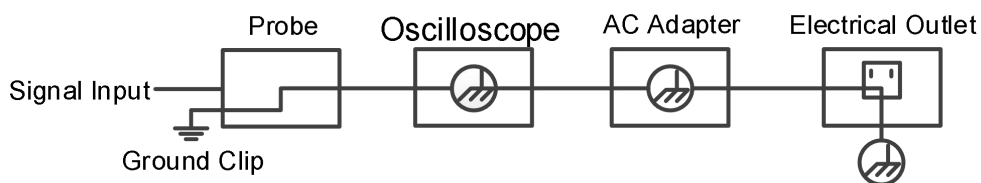

The diagram of internal ground connection when the instrument is connected to the computer (AC power supply) via a port.

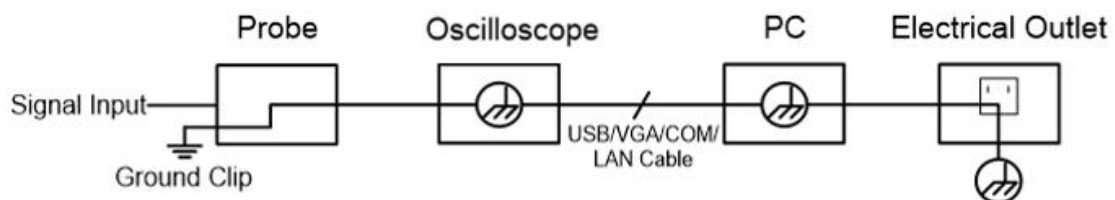

When the oscilloscope is powered by AC and connected to a computer with AC power supply via a port, the primary side of the power grid cannot be measured.



Warning:

To avoid fire or electrical shock, when the oscilloscope input signal connected is more than 42V peak (30Vrms) or on circuits of more than 4800VA, please take note of below items:

- Only use accessory insulated voltage probes and test lead.
- Check the accessories such as probe before use and replace it if there are any damages.
- Remove probes, test leads and other accessories immediately after use.
- Remove USB cable which connects oscilloscope and computer.
- Do not apply input voltages above the rating of the instrument because the probe tip voltage will directly transmit to the oscilloscope. Use with caution when the probe is set as 1:1.
- Do not use exposed metal BNC or banana plug connectors.
- Do not insert metal objects into connectors.

How To Conduct A General Inspection

After you get a new device, it is recommended that you should make a check on the instrument according to the following steps.

1. Check whether there is any damage caused by transportation.

If it is found that the packaging carton or the foamed plastic protection cushion has suffered serious damage, do not throw it away first till the complete device and its accessories succeed in the electrical and mechanical property tests.

2. Check the Accessories.

The supplied accessories have been already described in the "Appendix A: Accessories" of this Manual. You can check whether there is any loss of accessories with reference to this description. If it is found that there is any accessory lost or damaged, please get in touch with our distributor responsible for this service or our local offices.

3. Check the Complete Instrument.

If it is found that there is damage to the appearance of the instrument, or the instrument can not work normally, or fails in the performance test, please get in touch with our distributor responsible for this business or our local offices. If there is damage to the instrument caused by the transportation, please keep the package. With the transportation department or our distributor responsible for this business informed about it, a repairing or replacement of the instrument will be arranged by us.

How To Conduct Function Inspection

Conduct a quick function inspection to confirm if the instrument is running in normal state.

Power-on Inspection

To power on the instrument, long press(1~2 seconds)  in the lower left of the host.

The instrument screen shows the startup screen and wait a few seconds, the relay in the host will make a slight click sound. After performing all self-inspection items on the instrument, the instrument will directly enter instrument system.

3.Primary User Guide

The following are illustrated with four channels as an example, and for two channels, please refer to four channels.

Model	Channel
ADS802A	2
ADS804A	4
ADS812A	2
ADS814A	4
ADS822A	2
ADS824A	4

This chapter elaborates the following topics:

- [A general knowledge of the structure of the instrument](#)
- [A general knowledge of the user interface of the instrument](#)
- [How to conduct probe compensation](#)
- [How to set the probe attenuation coefficient](#)
- [How to use the probe safely](#)
- [How to conduct self-calibration](#)

A General Knowledge Of The Structure Of The Instrument

This chapter gives a brief description and introduction to the operations and functions of the front panel of the instrument, so as to facilitate your operations of the instrument in the shortest time.

Front Panel

On the instrument panel, knobs and function buttons are used to enter different function menus or directly use specific function application.

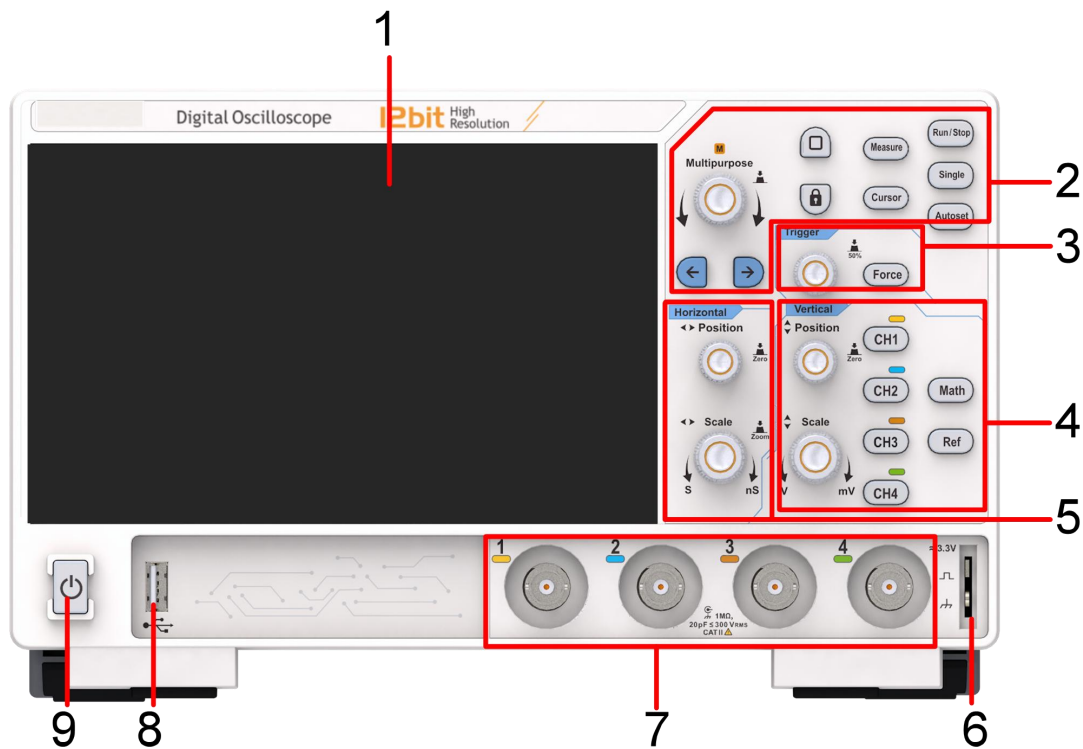
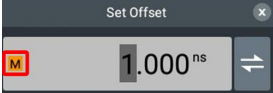





Figure 3-1: Front panel

1. The display area supports touch (Note: 10 seconds idle user configuration auto save).
2. General knob and arrow keys.
 - **General knob:** When **M** appears in the screen menu, it can be

turned to set the value. Example  can rotate the knob to change the offset value.

- **Arrow keys**  : Move to select the parameter.
- **Home key** : Return to the main homepage.
- **Touch key** : Press it to disable the touch screen, the key light turns on; and press it again to enable the touch screen, the key light turns off (**Note:** The Touch Lock is only available in EduInstr system and does not work on the main homepage and other application interface.).
- “Measure” key corresponds to enable/disable the measurement function.
- “Cursor” key corresponds to enable/disable the cursor function.
- Shortcut key: Run/Stop, Single, Autoset.

3. **Trigger control area:** Contain one key and one knob.

- “Trigger Level” knob is to adjust trigger level;
- Force key is the forced trigger shortcut key.

4. **Vertical control area:** Contain six keys and two knobs.

- “CH1”, “CH2”, “CH3”, “CH4” key are correspond to the channel switch of Channel 1, Channel 2, Channel 3 and Channel 4 respectively;
- “Math” key corresponds to enable/disable the waveform math function;
- “Ref” key corresponds to enable/disable the reference waveform function;
- “Vertical Position” knob is to control the vertical position of selected channel;
- “Vertical Scale” knob is to control the voltage scale for selected channel.

5. **Horizontal control area:** Contain two knobs.

- “Horizontal Position” knob is to control the horizontal position triggered.

- “Horizontal Scale” knob is to control time base scale.
6. Probe compensation: about 3.3V/1kHz signal output.
 7. Channel input port area.
 8. USB Host Interface: When the oscilloscope is connected to an external USB device as a “master device”, the USB Host interface is used to transmit the data (Note: the devices that can be connected include a mouse, keyboard, USB flash drive, etc.).
 9. Instrument switch with memory (self-lock) switch and auto memory of last shutdown; if the instrument is shut down by powering the supply off, there is no need to press the switch to start it up after next power-on; if the instrument is shut down by pressing the switch key, it is required to press the switch key again to power it on.

Rear Panel

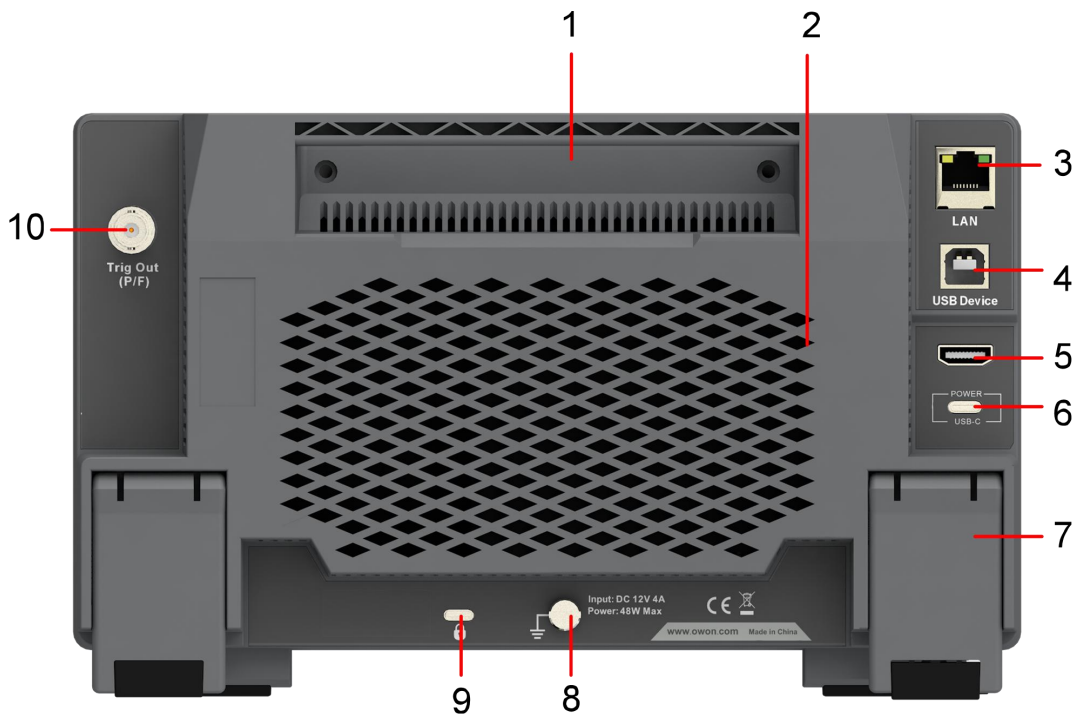

Figure 3-2: Rear Panel

1. Foldable Handle.
2. Heat Emission Hole.

3. LAN Interface: The network interface to connect a PC or router.
4. USB Device Interface: When the oscilloscope is connected to an external USB device as a “slave device”, the USB Device interface is used to transmit the data. For example, use the interface to connect a PC.
5. HDMI Interface: To connect HDMI output to the external monitor or projector.
6. USB-C power supply interface.
7. Foot Rest: To adjust the inclined angle of the oscilloscope.
8. Ground screw.
9. Safety lock.
- 10.Trig Out (P/F) Interface: Trigger output or pass/fail output port.

A General Knowledge Of The User Interface Of The Instrument

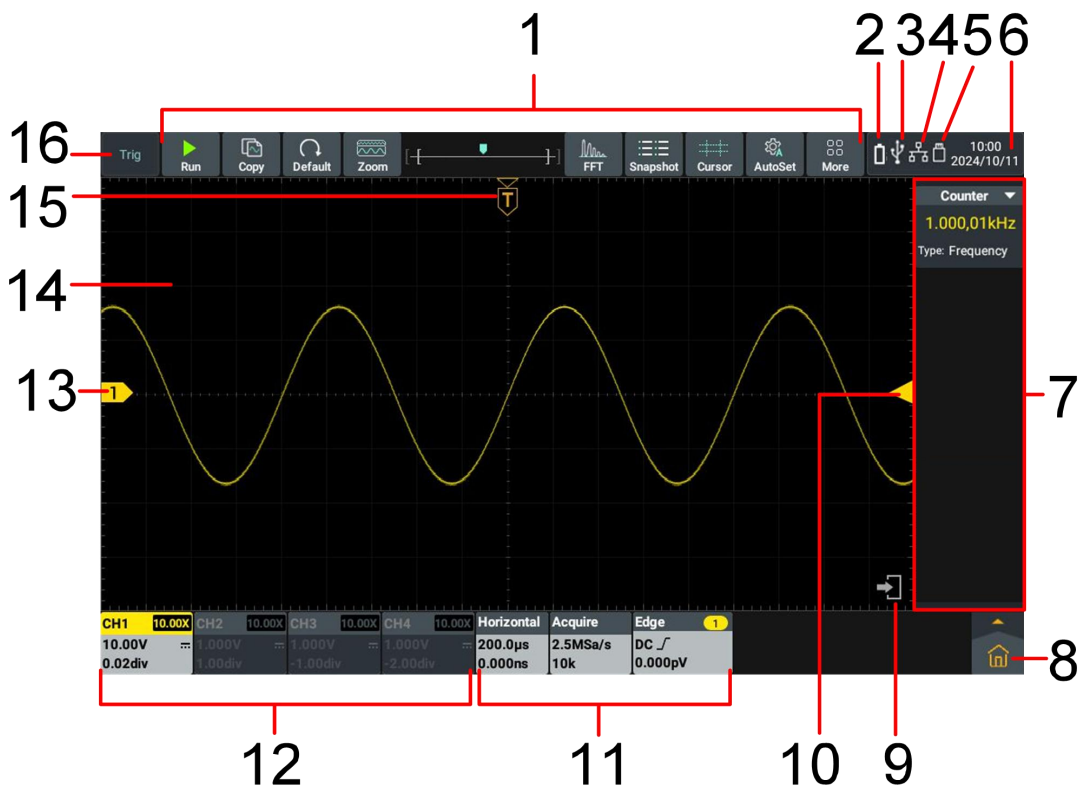







Figure 3-3:Illustrative Drawing of Display Interfaces

1. Shortcut soft keys of oscilloscope functions.

2. Battery Identifier (Optional).
3. USB Device access identifier.
4. LAN port access identifier (If icon for the  , it indicates the Wi-Fi is enabled and connected currently). Click the icon will switch to the Wireless&networks setting interface.
5. U disk access identifier.
6. System set time, click the icon will switch to the Date&time setting interface.
7. Counter and others function information display bar (Note: click / on the left corner corresponds to enable/disable statistic). Right swipe the information display bar to close the corresponding function.
8. Main menu key, click to show/hide the main menu.
9. Hide/show the information display bar on the right.
10. Trigger level position, press and hold can be center.
11. Function information display bar: display Horizontal, Acquire, Trigger information respectively. Click the bar can show/hide the corresponding setting window.
12. Channel information display bar. Display the configure information of Channel 1, Channel 2, Channel 3 and Channel 4 respectively (Note: The swipe down the bar can turn on or off the waveform display).
Among:
BW indicates that the bandwidth limit is 20MHz.
“” indicates DC coupling;
“” indicates AC coupling;
“” indicates Ground coupling.
13. Channel waveform.
14. Waveform display area.
15. Time base position, press and hold can be center.

16. Display the current running status.

Oscilloscope Inspection

1. Set the Switch in the Oscilloscope Probe as 10X and Connect the Oscilloscope with CH1 Channel.

Align the slot in the probe with the plug in the CH1 connector BNC, and then tighten the probe with rotating it to the right side.

Connect the probe tip and the ground clamp to the connector of the probe compensator.

2. Perform Autoset.

The square wave of 1 kHz frequency and about 3.3V peak-peak value will be displayed in several seconds (see Figure 3-4). Check CH2, CH3 and CH4 by repeating Step 2 and Step 3.

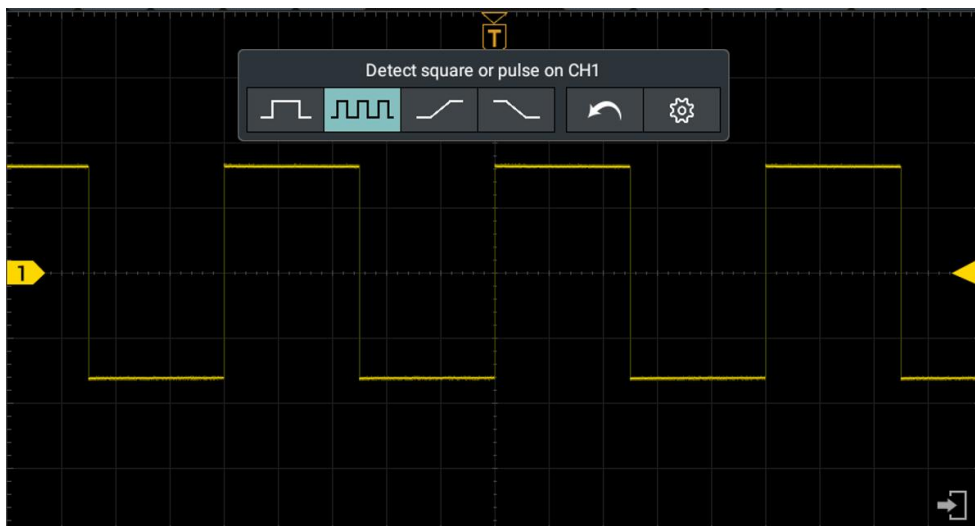

Figure 3-4:AutoSet

How To Implement The Probe Compensation

When connect the probe with any input channel for the first time, make this adjustment to match the probe with the input channel. The probe which is not compensated or presents a compensation deviation will result in the measuring error or mistake. For adjusting the probe compensation, please carry out the following steps:

1. Set the attenuation coefficient of the probe in the menu as 10X and that of the switch in the probe as 10X (see "How to Implement the Probe Compensation" on P14), and connect the probe with the CH1 channel. If a

probe hook tip is used, ensure that it keeps in close touch with the probe. Connect the probe tip with the signal connector of the probe compensator and connect the reference wire clamp with the ground wire connector of the probe connector, and then push the **Autoset** button on the front panel.

2. Check the displayed waveforms, see Figure 3-5. Regulate the probe till a correct compensation is achieved, see Figure 3-6.

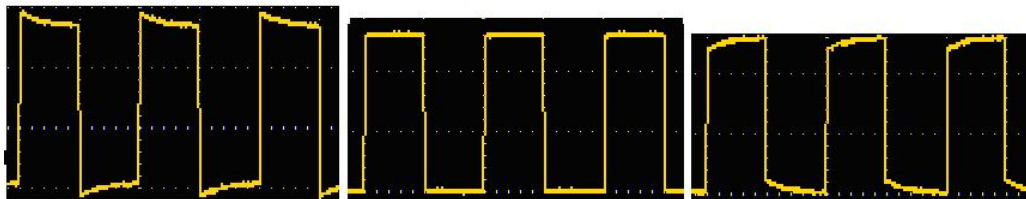

Overcompensated Compensated correctly Under compensated

Figure 3-5: Displayed Waveforms of the Probe Compensation

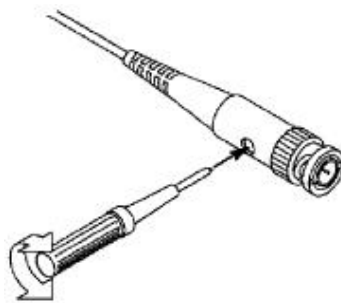

Figure 3-6: Adjust Probe

3. Repeat the steps mentioned if needed.

How To Set The Probe Attenuation Coefficient

The probe has several attenuation coefficients, which will influence the vertical scale factor of the oscilloscope.

To change or check the probe attenuation coefficient in the menu of oscilloscope:

1. Click the channel information display bar on the bottom left of the screen (CH1 Channel, CH2 Channel, CH3 Channel or CH4 Channel).
2. Select **Probe Attenu** (**1X**, **10X** or other custom probe magnifications) in the displayed channel setting window. The setting will remain in effect until changed again after selection.



Caution:

The default attenuation coefficient of the probe on the instrument is preset to 10X.

Make sure that the set value of the attenuation switch in the probe is the same as the menu selection of the probe attenuation coefficient in the oscilloscope.

The set values of the probe switch are **1X** and **10X**,see Figure 3-7.

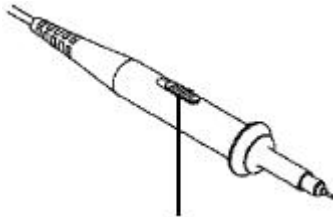

Figure 3-7: Attenuation Switch



Caution:

When the attenuation switch is set to 1X, the probe will limit the bandwidth of the oscilloscope in 5MHz. To use the full bandwidth of the oscilloscope, the switch must be set to 10X.

How To Use The Probe Safely

The safety guard ring around the probe body protects your finger against any electric shock, see Figure 3-8.

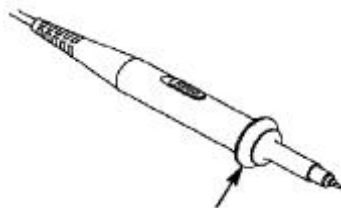

Figure 3-8: Finger Guard



Warning:

To avoid electric shock, always keep your finger behind the safety guard ring of the probe during the operation.

To protect you from suffering from the electric shock, do not touch any metal part of the probe tip when it is connected to the power supply.

Before making any measurements, always connect the probe to

the instrument and connect the ground terminal to the earth.

How To Conduct Self-Calibration

Self-calibration program is used to quickly make the oscilloscope be in the optimum condition to obtain the most accurate measurement. This program can be performed at any time. It is especially necessary when the ambient temperature reaches or exceeds 5°C.

To conduct self-calibration, disconnect all probes and wires from the input connector. Then, click “” in the lower right of the screen, select **Self-Calibration** from the menu displayed and click **Start** in the self-calibration display box.

4. Use the Android System

Android System Homepage Window



1. Application shortcut key. If you click the oscilloscope  shortcut key, you can enter the oscilloscope interface.
2. App Drawer (Click to see all apps).
3. Task key.
4. Home key.
5. Back key.

System Built-in Application List

Open the application drawer of the main page. The system built-in application including: APP Center, Calculator, Calendar, Clock, Email, File Explorer, Firefox, Gallery, Music, Oscilloscope, Screen Recorder, Settings, Sound Recorder, Web Service, as show in the following figure.

4. Use the Android System

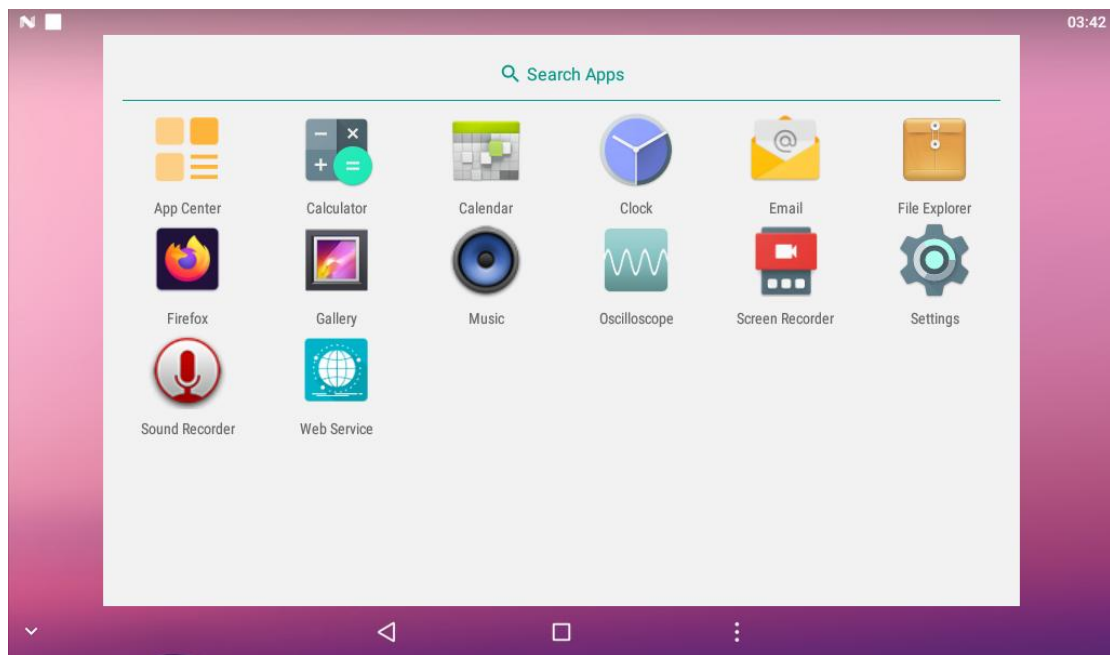

5. Use the Oscilloscope

A General Knowledge Of Oscilloscope

A General Knowledge Of Trigger System

As shown in Figure 5-1, there are one knob and one key. The following exercises are to guide you through the use of the trigger system.



Figure 5-1: Trigger control area

1. Use **Trigger Level** knob to change the settings of the trigger level.
Rotary the **Trigger Level** knob, the trigger pointer on the screen moves up and down as the knob turns. While moving the trigger pointer, the value of the trigger level on the screen changes accordingly.
Note: Turning the **Trigger Level** knob can not only change the trigger level value, but also set the shortcut key of the trigger level at the vertical midpoint of the trigger signal amplitude.
2. Press **Force** key to generate a trigger signal forcibly, mainly used in the “Normal” and “Single” trigger mode.

A General Knowledge Of Horizontal System

As shown in Figure 5-2, there are two knobs. The following exercises to guide you through the use of the horizontal system.

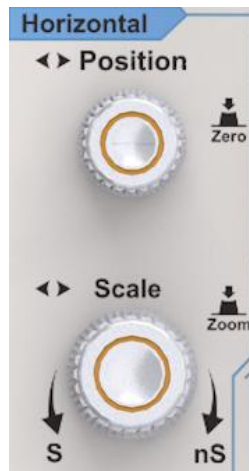

Figure 5-2: Horizontal control area

1. Rotary **Horizontal Position** knob to adjust the horizontal position of the signal in the waveform window.
The **Horizontal Position** knob is to control the triggered horizontal position of the signal; when turning the knob, the waveform moves horizontally with the knob. When pressing the **Horizontal Position** key, the horizontal displacement can be zero.
2. Rotary the **Horizontal Scale** knob to change the settings of the horizontal time base and thus observe the resulting change of the status information, then the corresponding **Horizontal Time Base** in the status bar changes accordingly. Press the **Horizontal Scale** knob enter or exit waveform zoom mode.

A General Knowledge Of Vertical System

As shown in Figure 5-3, there are six keys and two knobs. The following exercises are to guide you through the use of the vertical system.

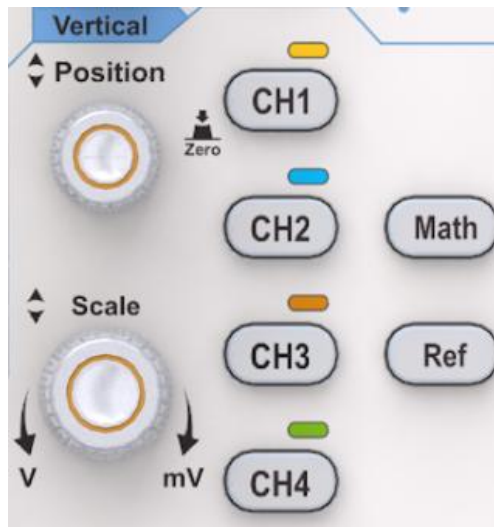

Figure 5-3: Vertical control area

1. **Vertical Position** knob to control the vertical display position of the signal. When turning the Vertical Position knob, the pointer indicating the **Grounding Reference Point** of the channel moves up and down following the waveform. When pressing the **Vertical Vertical** key, the vertical position can be zero.

Measuring Skills

If the DC coupling mode is adopted for the channel, observe the gap between the waveform and the signal ground to quickly measure the DC component of the signal.

If the AC coupling mode is adopted for the channel, the DC component of the signal is filtered out, facilitating you to display the AC component of the signal with higher sensitivity.

If the Ground coupling mode is adopted for the channel, indicates that the internal input is grounded and the external input is disconnected. It can effectively reduce the influence of external interference on the measurement results and ensure the accuracy of the measurement.

2. Change the vertical settings and observe the resulting status change. You can determine the change of the vertical scale factor of any channel through the information displayed in the information display bar at the lower part of the waveform window.
 - Turn the **Vertical Scale** knob to change the **Vertical Scale Factor (Voltage Scale)**, and the scale factor of corresponding channel in the

- information display bar changes accordingly.
3. Press CH1、CH2、CH3、CH4 key to enable or disable the corresponding channel.
 - If the current channel is disable, press it to enable and select the channel;
 - If the current channel is enable but no selected, press it to select the channel;
 - If the current channel is enable and selected, press it to disable the channel.
 4. Press **Math** key to enable/disable waveform math function; press **Ref** key to enable/disable reference waveform function.

How To Use Touch Screen Control

The touch screen can be used to control the oscilloscope by various gestures.

Operate the touch screen when the light of the touch lock in the upper right of the front panel is off; click the key to light up the indicator; the touch function is disabled when the touch lock is in locked state.

The instructions of the touch screen operations are as follows, the contents in the parentheses indicate the key or knob that plays the same role.

Use The Touch Screen To Operate The Menu

- **Open the Settings window function:** Directly click the below or right information display bar to pop up the corresponding function of the setting window.
- **Set Menu Item:** In the Settings window, you can change the configuration of the relevant menu item by touching it. The types of operable parts include: switch, button, multiple choice, gear hobbing (scrolling list), etc. The following box selects the multiple choice, click directly to switch the options.

5. Use the Oscilloscope



- **Scroll List:** When the scroll bar appears in the menu, swipe the screen up and down with the finger to scroll the list, as shown in the figure below.



- **Open Main Menu:** Click the  icon in the lower right of the display area, the main menu window pops up, as shown below. Click each item in the main menu window to open the settings window of the corresponding function, and click the shortcut key at the top of the screen to open the corresponding function.

Click the shortcut key to open the corresponding function directly



Click on the items in the main menu window to open the corresponding settings window.

Operate The Touch Screen

- **Select a Channel (CH1 channel, CH2 channel, CH3 channel or CH4 channel):** Click the channel pointer on the left or click the channel waveform to make the channel pointer selected. Long press the channel pointer, the vertical position of waveform can be center.

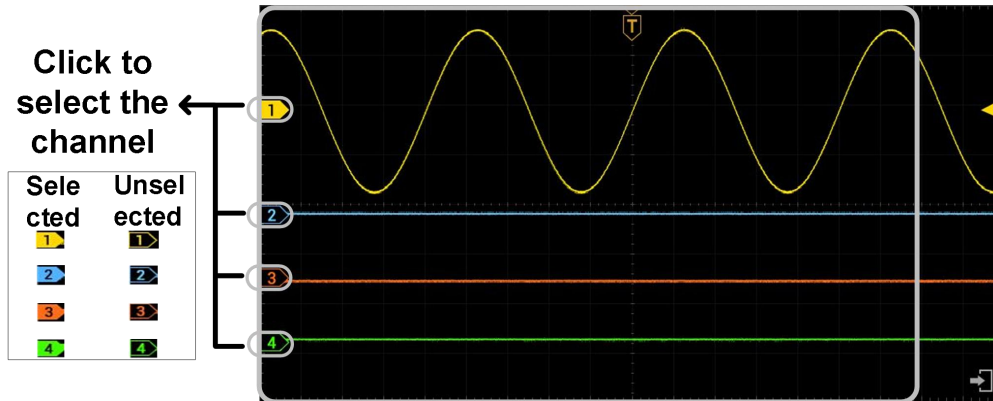

- **Set the vertical position of the selected channel waveform (Vertical Position knob):** The vertical position of the waveform can be changed by swiping your finger up and down in the blank position of the waveform display area, as shown in the figure below.

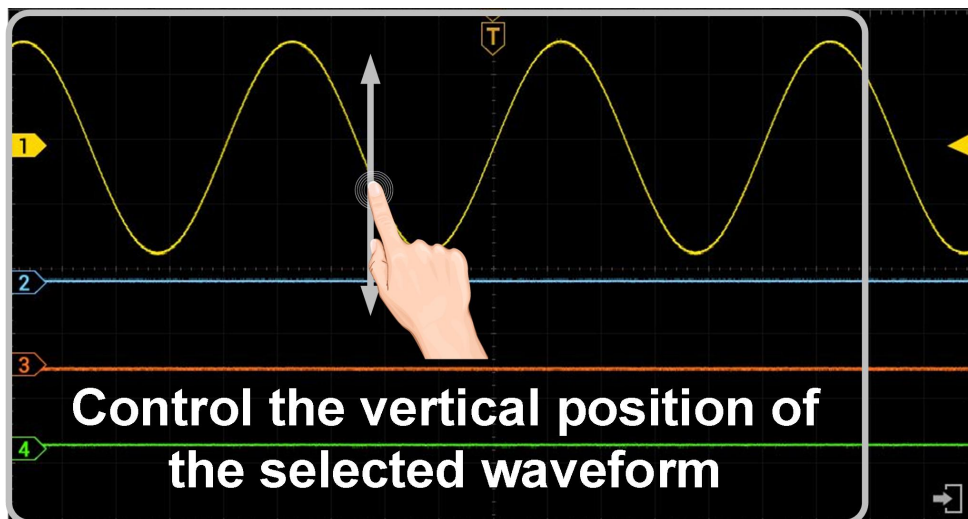

- **Set the trigger level of the signal source in the Trigger Menu (Trigger Level knob):** The two grids on the right of the waveform area are the trigger level touch moving area, and the trigger level can be changed by sliding up and down in this area, as shown in the figure below.

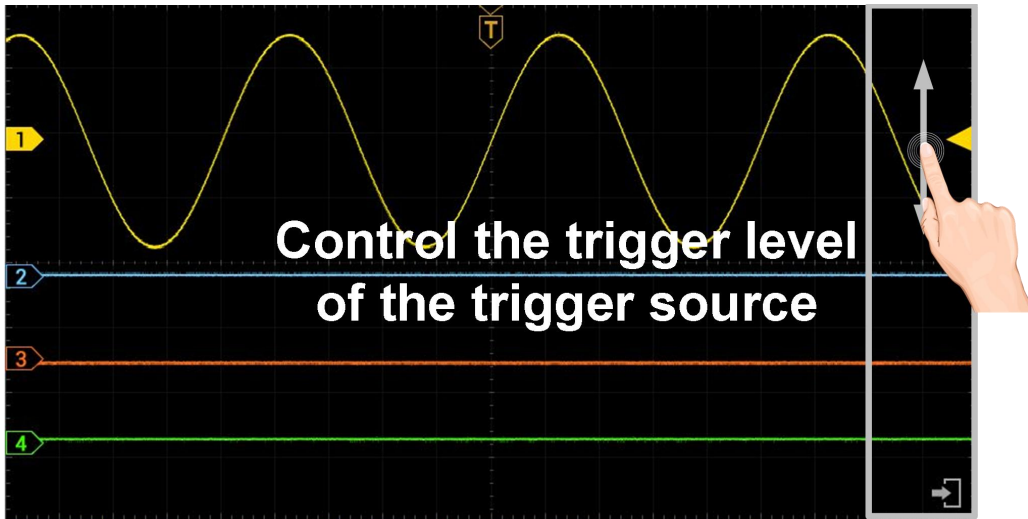

- **Set Horizontal Position (Horizontal Position knob):** The horizontal position of the waveform can be changed by swiping your finger around the waveform display area, as shown in the figure below.

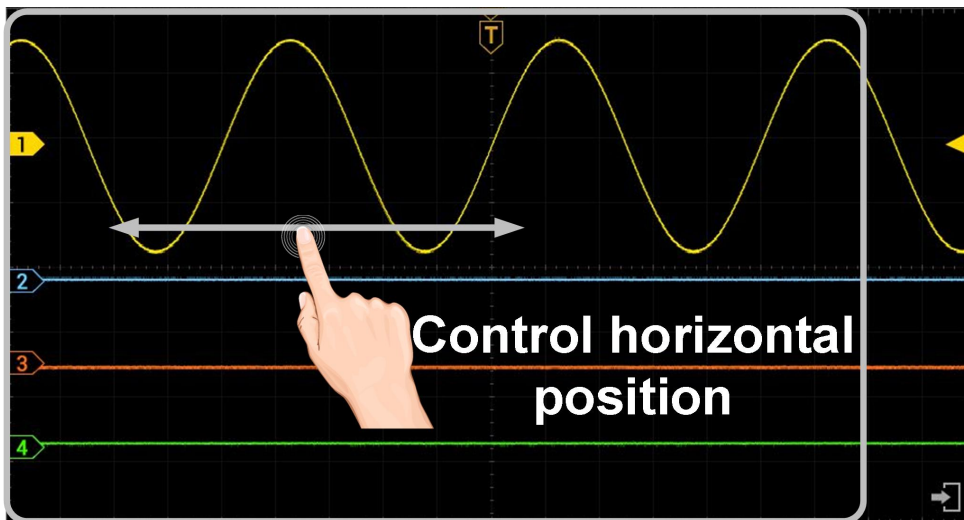

- **The control voltage gear and time base can be scaled in the following way:**
 - In the waveform display area, up and down/left and right zoom thumb and index finger to zoom control voltage scale and time base, as shown in the figure below.

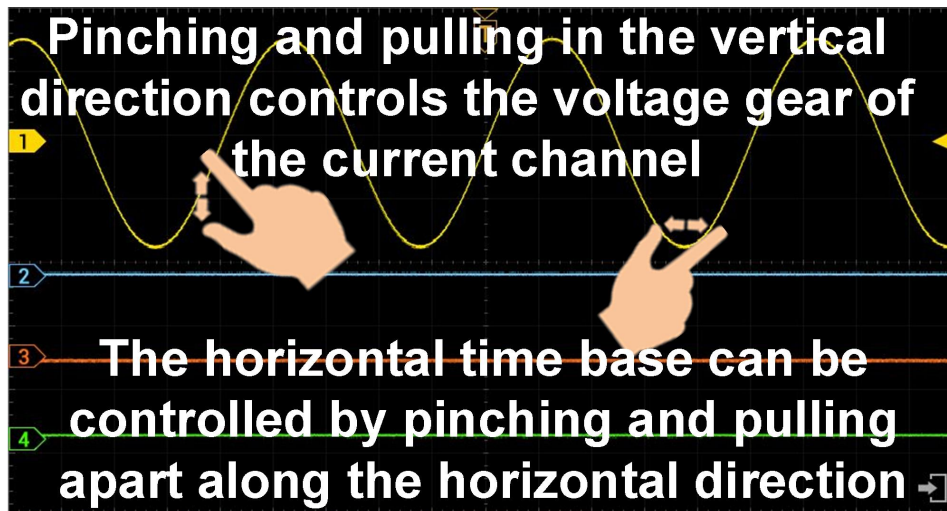

- In the waveform display area, double-click the screen and slide the hand up and down/left and right to zoom the control voltage scale and time base.

Operate The Touch Screen In Waveform Amplification Mode

Press **Horizontal Scale** knob to enter the waveform zoom mode, the main window is displayed at the top half of the screen and the amplified window is displayed at the bottom half of the screen. The amplified window is the amplified part of the main window that is selected.

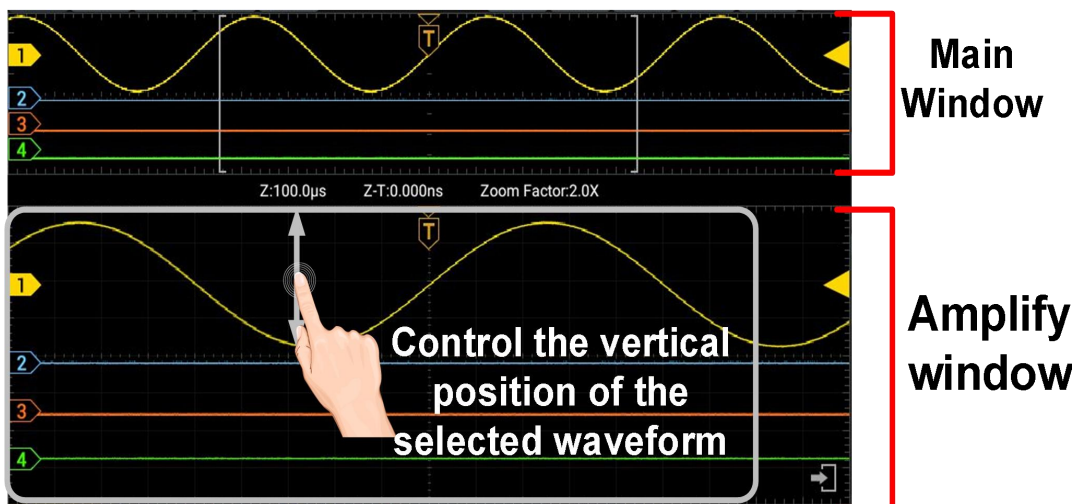

5. Use the Oscilloscope

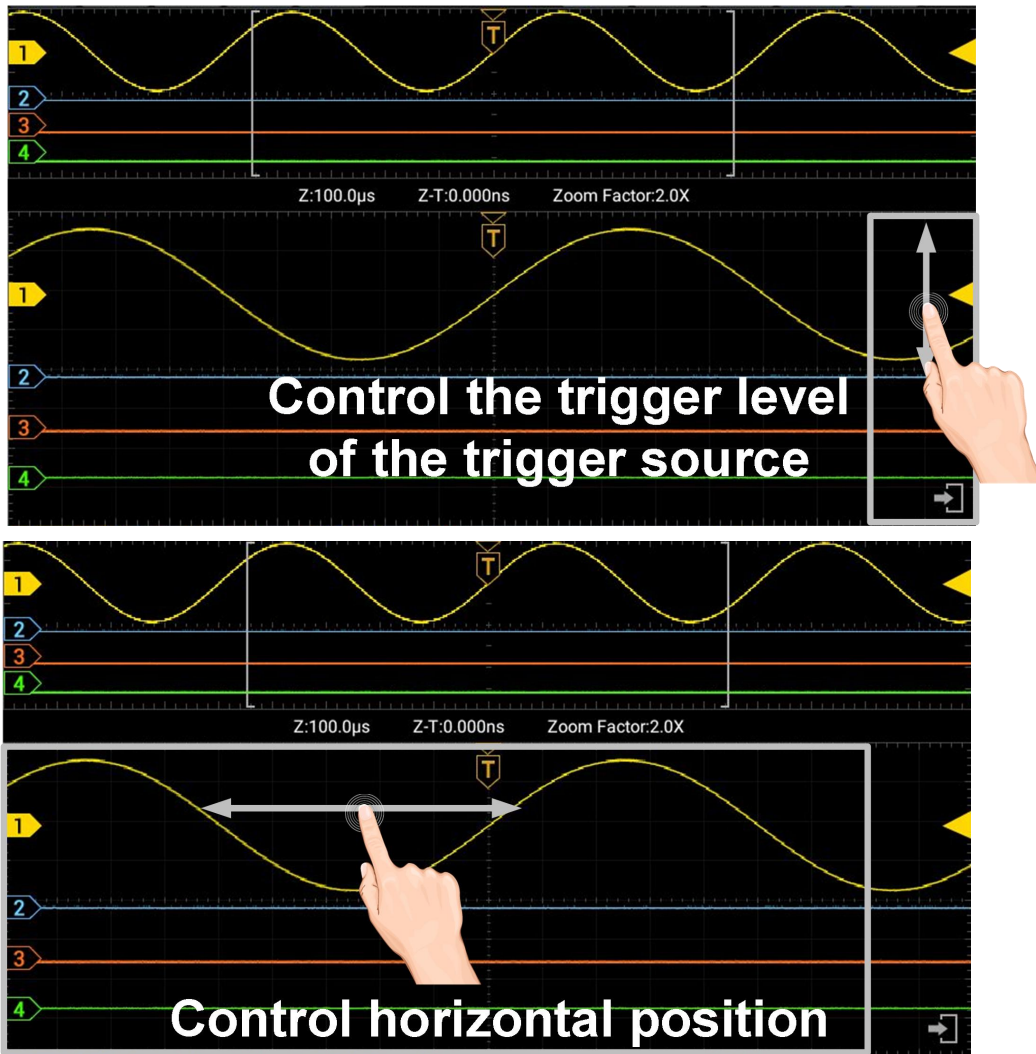

Other Touch Screen Operations

- Click and drag the open menu item to move it into the appropriate location.

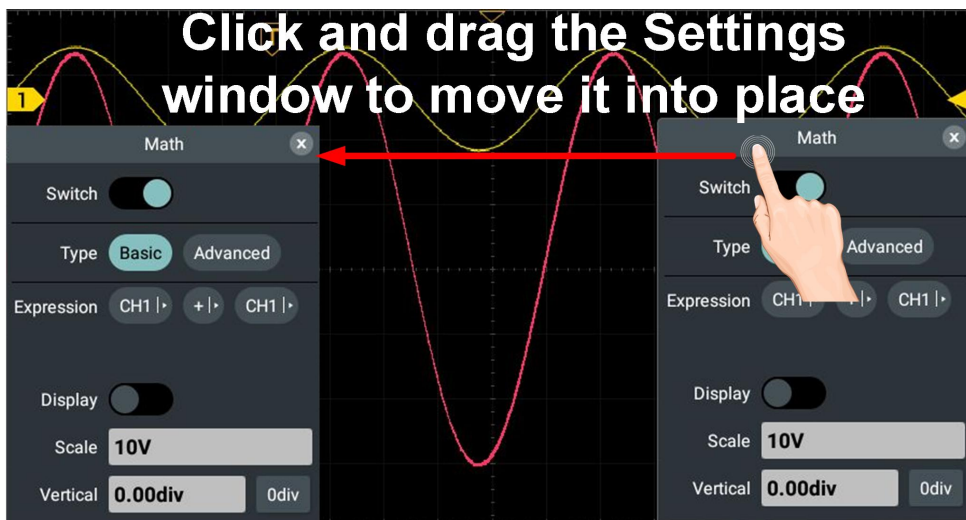

- Control the horizontal or vertical cursor lines under cursor measurement,

as shown in the figure below.

Click to select the cursor

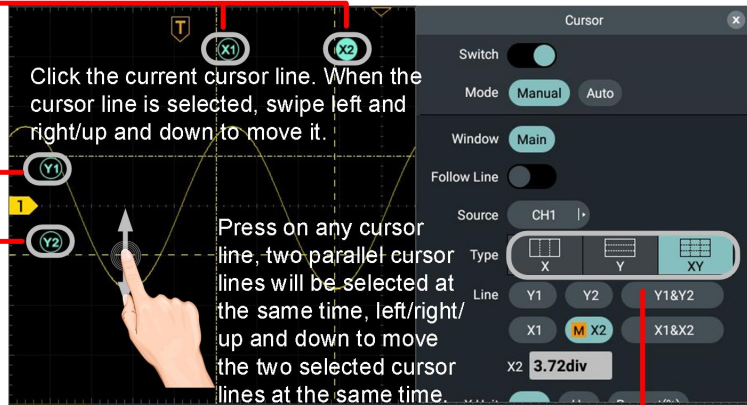
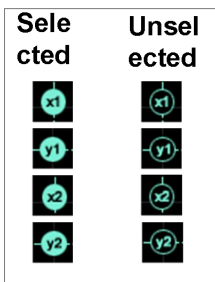

**Toggle horizontal/vertical/
horizontal & vertical cursor lines**

- **Run/Stop:** Click or in the upper left of the display area to switch Run/Stop.
- **Parameter Setting Keyboard in Menu Item:** There are digital input mode and hobbing input mode.

Digital input mode, as shown in the figure below.

Value reset Backspace key

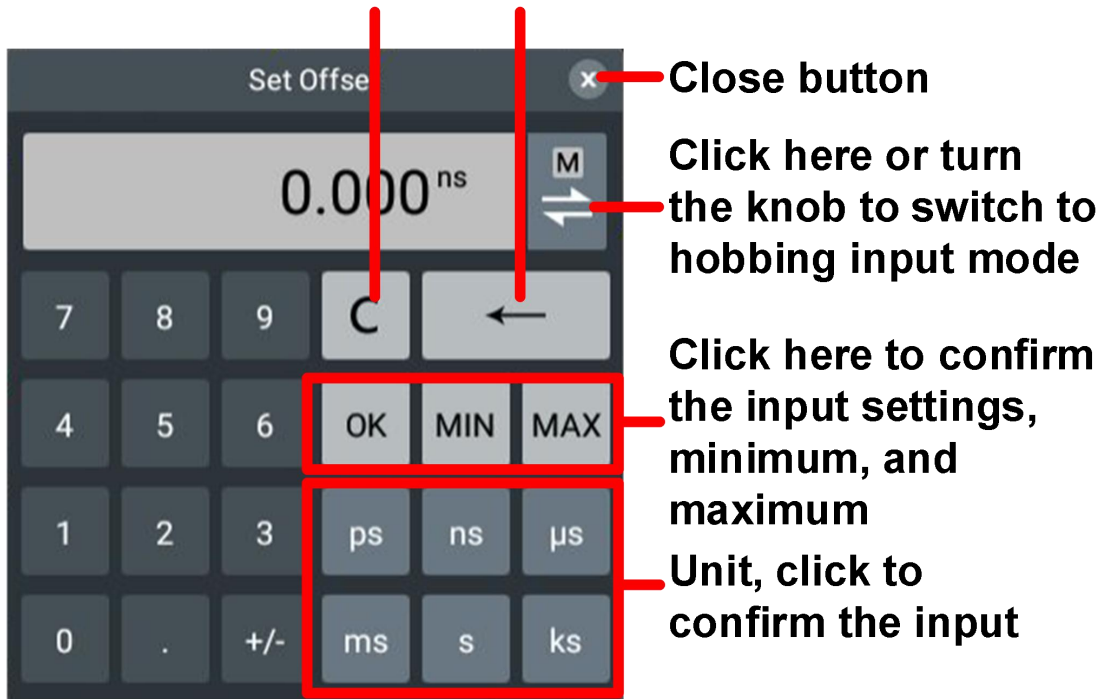

Hobbing input mode, as shown in the figure below.

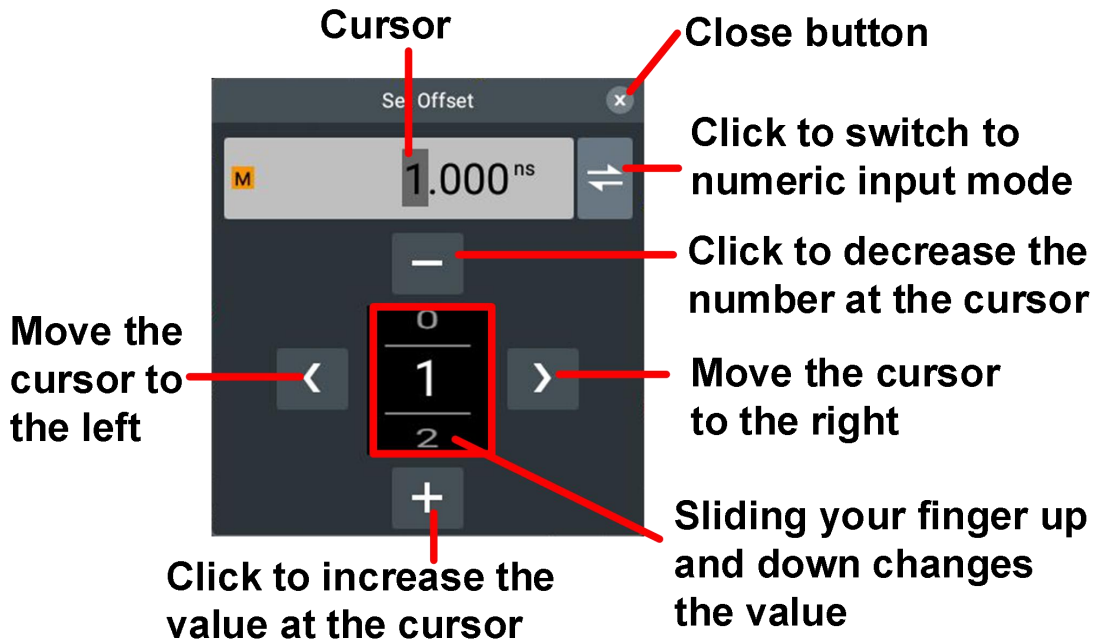

- **Swipe the information display bar**

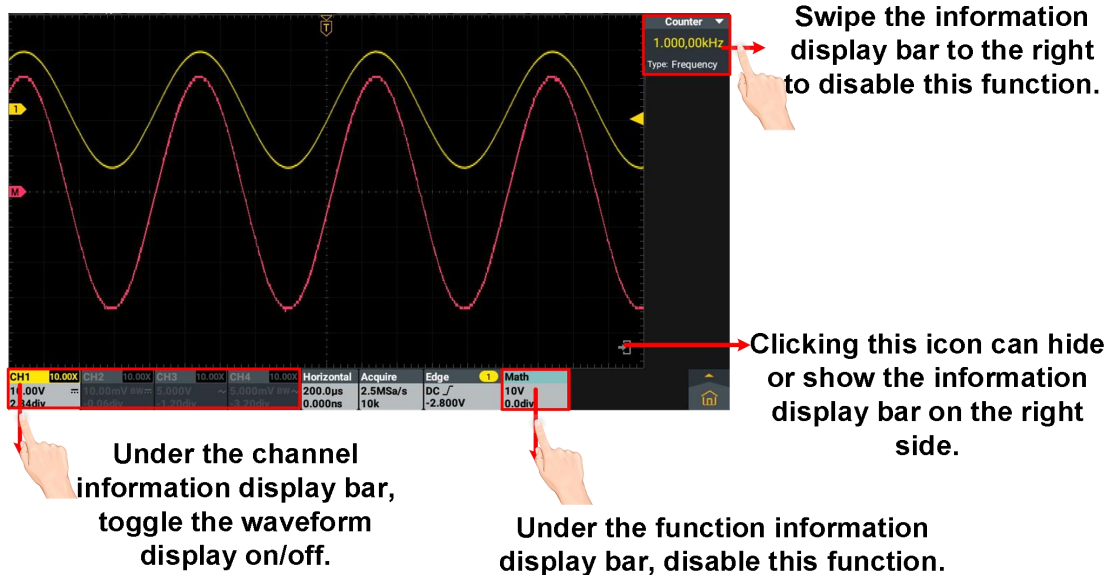

Advanced User Guide for Oscilloscope

In the previous chapter, basic operations of the oscilloscope, function area of the front panel and the roles of the keys and knobs are introduced for the user to determine the change of instrument settings by observing the status bar. For any details of the operations and methods mentioned above, refer to Chapter 3 “Primary User Guide”.

- [How To Set Vertical System](#)
- [How To Set Horizontal System](#)
- [How To Set Acquire](#)
- [How To Set Trigger](#)
- [How To Set Automatic Measurement](#)
- [How To Set XY Mode](#)
- [How To Set Cursor Measurement](#)
- [How To Realize Waveform Operation Function](#)
- [How To Set FFT](#)
- [How To Set DIR\(Digital Filtering\)](#)
- [How To Set Pass Fail](#)
- [How To Set Counter](#)
- [How To Set DVM](#)
- [How To Set Decode](#)
- [How To Set Waveform Record/Player](#)
- [How To Set Display System](#)
- [How To Set Save And Print](#)
- [How To Set Reference Waveform](#)
- [How To Conduct Self-Calibration](#)
- [How To Conduct Probe Check](#)
- [How To Use Execution Keys](#)

Please carefully read this chapter to understand various measuring functions and other operation methods of the oscilloscope.

How To Set Vertical System

In the vertical system control area, there are six keys (**CH1, CH2, CH3, CH4, Math and Ref**) and two knobs (**Vertical Position** knob and **Vertical Scale** knob).

Channel Settings

Each channel is equipped with the independent vertical menu, and each item is set separately based on different channel.

How to enable or disable the waveform (channel)

- (1) Press **CH1, CH2, CH3, CH4** key produces the following results:
 - If the channel disable, press it enable the channel.
 - If the channel enable but no selected, press it select the channel.
 - If the channel enable and selected, press it disable the channel.
- (2) Swipe down **CH1, CH2, CH3, CH4** information display bar produces the following results:
 - If the channel disable, swipe down it enable the channel.
 - If the channel enable, swipe down it disable the channel.
- (3) Click **CH1, CH2, CH3, CH4** information display bar produces the following results:
 - If the channel disable, click it enable and selected the channel.
 - If the channel enable but no selected, click it selected the channel.
 - If the channel enable and selected, click it open/close channel setting.

How to open the channel settings

Click the information display bar on the lower left corner of the screen, it will pop up the setting window.

Channel setting window is described in the table below:

Menu	Settings	Descriptions
Display		Click to open/close the channel waveform.

5. Use the Oscilloscope

Coupling	DC	Pass the AC and DC component of the input signal.
	AC	Block the DC component of the input signal.
	Ground	Disconnect the input signal.
Inverted		Click to open or close the waveform inversion function.
Probe Attenu	Common	Click the Numeric Display Box and turn General knob or swipe the screen up and down in the numeric select box with the finger to select commonly used magnification; it is also available to set 1X and 10X probe magnification with 1X and 10X keys.
	Custom	Click the Numeric Display Box to set the probe magnification within the range between 1uX and 1MX.
Label		Click the switch to the right of the Label item to choose to display or not display the channel label.
	Common	Set a common display label for a channel. Click the label box, adjust the universal knob or swipe up and down in the label selection box with your finger to select some commonly used labels.
	Custom	Click on the channel label input box and enter the string directly through the letter keyboard that pops up.
Unit	V A W U	Set the display unit of current channel as required.
Limit	20MHz	Limit to 20MHz to reduce the display noise.
	All	The bandwidth of the oscilloscope.
Expand	Center	Based on the vertical center point of the screen, the waveform will be scaled around the vertical center point of the oscilloscope screen.
	Offset	Based on the vertical zero point of the channel, the waveform will be scaled around the channel's zero level.

5. Use the Oscilloscope

Scale	500.0uV 1.000mV 2.000mV 5.000mV 10.00mV 20.00mV 50.00mV	100.0mV 200.0mV 500.0mV 1.000V 2.000V 5.000V 10.00V	Select the optimum gear as required. Note: ● Current unit selection is V and the voltage gear of the probe multiplier is 1X.
Offset	div, Current Unit Vertical position settings		According to requirement to set offset unit. Set the vertical display position of the waveform; due to limited screen display, the visible range is ± 4 div.

Channel 1 is taken as an example to set the channel, and the operation steps are as follows:

1. Set the channel coupling

The measured signal is a square-wave signal with DC bias.

- (1) Click the **CH1** information display bar to bring up the **CH1** Settings window.
- (2) Click **Display** switch in the menu to highlight it.
- (3) Select coupling mode in the **Coupling** option.
 - Select **DC** to set to DC Coupling mode. Both DC and AC components contained in the measured signal can be passed through.
 - Select **AC** to set to AC Coupling mode. DC components contained in the measured signal will be blocked.
 - Select **Ground** to set to Ground Coupling mode. Disconnect the input signal.

2. Set waveform inversion

Waveform inversion: Flip the displayed signal 180 degrees relative to the ground potential.

- (1) Click the **CH1** information display bar to bring up the **CH1** Settings window.
- (2) Click **Display** switch in the menu to highlight it.
- (3) Click **Inverted** switch to highlight it, the waveform inversion will be

enabled. Click **Inverted** switch gain to gray it, the waveform inversion will be disabled.

3. Adjust Probe Ratio

It is required to adjust the coefficient of the probe attenuation ratio in the channel operation menu (see “How to Set the Probe Attenuation Coefficient” in Page 15). If the probe attenuation coefficient is 1:1, the input channel ratio of the channel shall also be set to 1X, so as to avoid errors in the displayed gear factors and measured data.

- (1) Click the **CH1** information display bar to bring up the **CH1** Settings window.
- (2) Click **Display** switch in the menu to highlight it.
- (3) Select **10X** in the **Probe Attenu** option.

4. Set channel label

- (1) Click the **CH1** information display bar to bring up the **CH1** Settings window.
- (2) Click **Display** switch in the menu to highlight it.
- (3) Click **Label** switch to highlight it. According to the requirement by selecting **Common** or **Custom** mode to set the channel label.

5. Set amplitude unit

- (1) Click the **CH1** information display bar to bring up the **CH1** Settings window.
- (2) Click **Display** switch in the menu to highlight it.
- (3) Click **Unit** menu, the optional units are V, A, W and U. Default unit is V.

6. Set bandwidth limit

- (1) Click the **CH1** information display bar to bring up the **CH1** Settings window.
- (2) Click **Display** switch in the menu to highlight it.

- (3) Select the oscilloscope bandwidth in the **Limit** option.
 - Click **20MHz**. The bandwidth is limited to 20MHz and the high-frequency components larger than 20MHz contained in the measured signal will be blocked.
 - Click **All**. The high-frequency components contained in the measured signal can be passed through.

7. Set expand

- (1) Click the **CH1** information display bar to bring up the **CH1** Settings window.
- (2) Click **Display** switch in the menu to highlight it.
- (3) Click **Expand** menu to select the waveform scaling method.
 - Click **Center**. The waveform will be scaled around the vertical center point of the oscilloscope screen.
 - Click **Offset**. The waveform will be scaled around the channel's vertical zero point (zero level).

8. Set voltage scale

- (1) Click the **CH1** information display bar to bring up the **CH1** Settings window.
- (2) Click **Display** switch in the menu to highlight it.
- (3) Click the numeric box in the **Scale** option to display the scale select box. It is available to swipe the screen up and down with the finger to select the required scale value.

9. Set vertical position

- (1) Click the **CH1** information display bar to bring up the **CH1** Settings window.
- (2) Click **Display** switch in the menu to highlight it.
- (3) Click the numeric value in the **Offset** option to display the setup box of vertical position; it is available to directly input the value or turn the

general knob to set the required vertical position.

Application of Math key and Ref key

See "How to Realize Waveform Operation Function" on page 82 for the Math key.

See "How To Set Reference Waveform" on page 127 for the Ref key.

Application of Vertical Position knob and Vertical Scale knob

1. **Vertical Position** knob to adjust the vertical position of corresponding channel waveform.
2. **Vertical Scale** knob to adjust the vertical resolution of corresponding channel waveform.

The vertical position and vertical channel information are shown in the lower left of the screen, as shown in Figure 5-4.

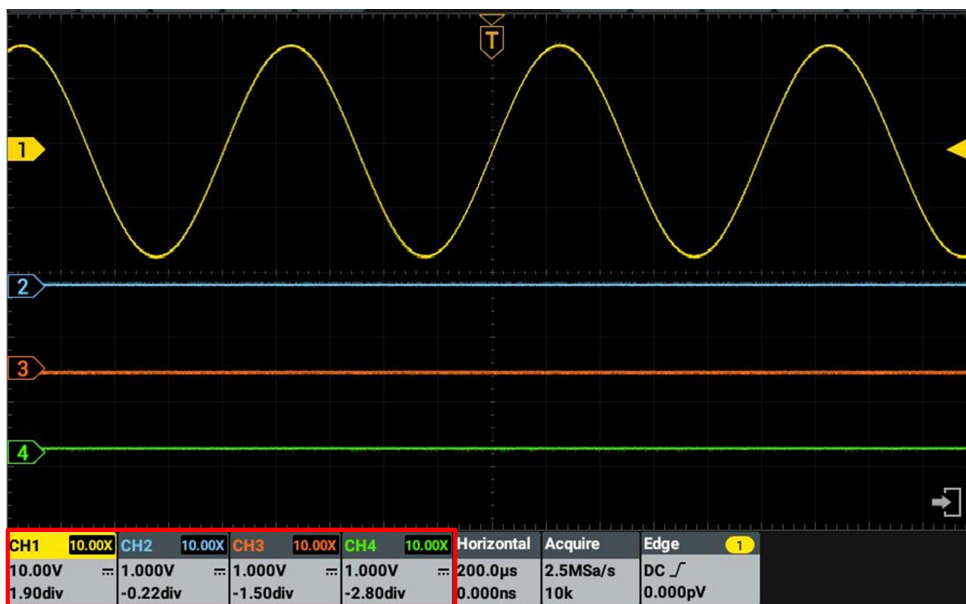

Figure 5-4: Vertical information

How To Set Horizontal System

There are **Horizontal Position** knob and **Horizontal Scale** knob in the Horizontal System Control Area.

1. **Horizontal Position** knob: Adjust the horizontal position of all channels (including the mathematical operation), whose resolution changes with the

time base.

2. **Horizontal Scale** knob: Set the horizontal scale factor for the main window or amplified window.

The descriptions of **horizontal system** menu are shown in the table below:

Menu	Settings	Descriptions
Zoom Mode		Click to open/close zoom mode.
Navigate		Through the navigation function, observe the situation of moving waveform. Note: The navigation function is used only when the running status is STOP (Acquire stop).
Expand	Center	Horizontal expansion refers to the reference position on which the screen waveform is horizontally expanded or compressed when the horizontal time base is adjusted. This instrument supports horizontal extension data including centers and trigger points default to "centers". Center: When changing the horizontal time base, the waveform expands or compresses horizontally around the center of the screen.
	Trigger	Trigger: When the horizontal time base is changed, the waveform expands or compresses horizontally around the trigger point.
Time Base		Set the horizontal time base scale of window.
Offset		Set the horizontal position of windows.

Waveform Amplification

Click the panel horizontal control area **Horizontal Scale** knob or click the **Horizontal Information Display Bar** at the lower part of the screen, display Horizontal Setting Window, click **Zoom Mode** switch to highlight it and enter the waveform amplification mode; the main window is displayed at the top half of the screen and the amplified window is displayed at the bottom half of the screen. The amplified window is the amplified part of the main window that is selected.



In normal mode, the **Horizontal Position** knob and the **Horizontal Scale** knob are used to adjust the horizontal position and the horizontal time base of the main window.



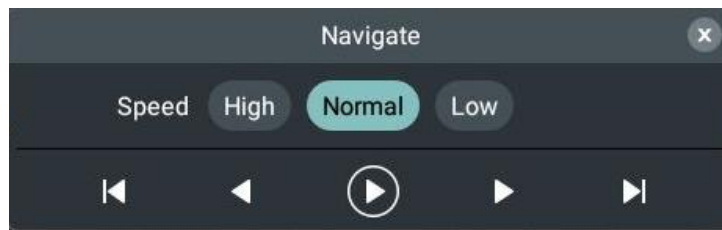

In waveform amplification mode, the **Horizontal Position** knob and the **Horizontal Scale** knob are used to adjust the horizontal position and the horizontal time base of the amplified window.

Navigate function



- (1) Click the bottom of screen **Horizontal Information Display Bar**, display horizontal setting window.
- (2) Click **Navigate** to enter navigate setting window.
- (3) Click **High**, **Normal**, **Low** can select waveform play speed.
- (4) Click **▶** or **⏸** can start/stop playing.
- (5) **In the run mode:** Click **◀**, the waveform can play directly to the far left; click **▶** the waveform can play directly to the far right. Click **◀**

(Play left) or  (Play right) can change the play direction, and it stops playing when it reaches the leftmost or rightmost end.

In the stop mode: Click , the waveform can play directly to the far left; click  the waveform can play directly to the far right. Click  or  the waveform can be shifted one step to the left / right.

(6) Click  can close the navigation setting window and function.

Note:

- For the operations related to the touch screen, refer to “How to use touch screen control” in page 23.

How To Set Acquire

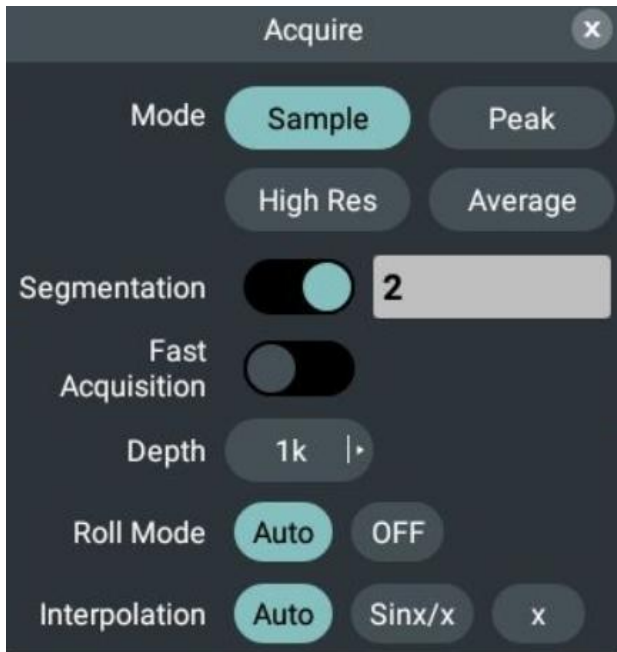

Click the bottom of screen **Acquire Information Display Bar**, the setting window as shown in the figure below.



The descriptions of setting window are shown in the table below:

Menu	Setting	Descriptions
Mode	Sample	General Acquisition mode.
	Peak	Used to detect interference burrs and possibility of reduce confusion.
	High Res	Reduce and improve the signal-to-noise ratio on aperiodic (single-shot) waveforms.

5. Use the Oscilloscope

	Average	Used to reduce random and irrelevant noise in signal. Click the number input box and scroll down the list to the right to select the average count.
Segmentation		Click to enable/disable the segment acquisition function. When the function is turned on, click Numeric Input Box to input the number of segment acquisition and click OK to confirm; or click Gear Input Box (- or +) or turn the General knob to set the number of segment acquisition, and click < > or press  or  to move the cursor and select the digit to be set.
Fast Acquisition		This feature is displayed only when segmented acquisition is enabled. When this feature is enabled, it can improve waveform capture rate, but the memory depth cannot be adjusted and is fixed at 1k. Additionally, when enabled, if the device is in pause mode, the horizontal position, time base, vertical position, voltage scale, and channel switching cannot be adjusted.
Depth		Click  , to select the length to be recorded on the right display box. Note: The length of the collected record is dynamic, changing with the number of channels opened and acquire mode.
Roll Mode	Auto OFF	As the acquisition proceeds, new data will continue to scroll sideways on the screen. In rolling mode, the oscilloscope samples the waveform without interruption without dead time. The waveform is displayed slowly moving from the right side of the screen to the left, and the fixed reference point on the screen is on the right edge of the screen to indicate the current time. The existing waveform is scrolled to the left of the reference point, and the newly acquired waveform always appears on the right side of the screen.
Interpolation	Auto Sinx/x x	When Auto is selected, it is in Sinx mode when running and in x mode when it stops running. Sine interpolation, using a curve connection between the sampling points. Linear interpolation, using straight line connections between sampling points. This interpolation method is more suitable for signals with straight edges, such as square wave, pulse wave, etc.

Segmentation Description

1. Functional Description

Segmentation (also known as sequence mode) is a powerful waveform capture function that divides the oscilloscope's acquisition memory into multiple independent segments. Unlike standard acquisition mode, which continuously records all signals, sectional acquisition mode only collects data when user-defined trigger events are detected. By ignoring the "dead time" (uninteresting signals or idle periods) between trigger events, this mode greatly improves memory utilization efficiency. This enables you to capture thousands of specific events at high sampling rates over long periods of time, which would be impossible in standard mode. Each captured segment is accompanied by an accurate timestamp, recording the exact time of event occurrence.

2. Operation Description

(1) Click the **Acquire** information bar at the bottom of the screen to enter the acquisition settings window.

(2) Click the **Segmentation** switch in the menu to highlight it.

(3) After enabling the function, the trigger mode switches to normal. A Segmentation input field appears in the settings window, where you can enter the desired number of acquisition segments.

(4) Once entered, if the number of segments is 100, the instrument will acquire 100 frames of triggered waveforms. After acquisition, these 100 frames will be displayed on the screen.

(5) Press the **Run/Stop** button to playback the acquired data.

How To Set Trigger

Trigger determines when the oscilloscope starts to collect the data and display the waveform. Once it is set properly, it can convert unstable display into the meaningful waveform.

When the oscilloscope starts to collect the data, enough data are used to draw the waveform at the left of the trigger point. The oscilloscope continuously collects data while waiting for the trigger conditions. When a trigger is detected, the oscilloscope will continuously collect enough data to draw the waveform at the right of the trigger point.

There is one knob and one keys in the Trigger Control Area.

Trigger Level: Turn this knob to set the signal voltage of corresponding trigger point and press this knob to make the trigger level at the vertical midpoint of the trigger signal amplitude.

Forced Trigger: Generate a trigger signal forcibly, mainly used in the “Normal” and “Single” trigger mode.

Trigger Control

Enter the trigger control:

Trigger Information Display Bar Operation: Click **Edge** information display bar at the lower part of the screen to pop up the trigger setting window on the screen, then directly click **Type** to select the trigger mode.

There are 14 trigger modes, including **Edge Trigger, Video Trigger, Pulse Trigger, Slope Trigger, Runt Trigger, Windows Trigger, Timeout Trigger, Nth Edge Trigger, Logic Trigger, RS232/UART Trigger, I2C Trigger, SPI Trigger, CAN Trigger and LIN Trigger.**

These 14 trigger modes are illustrated as follows.

Edge Trigger





Trigger on the trigger level of the input signal edge. When the “Edge Trigger” is selected, it is triggered on the rising edge and falling edge of the input signal.

Enter the edge trigger and the trigger setting information is displayed at the lower part of the screen, such as , indicating that the edge trigger is selected with the trigger signal source of CH1, trigger coupling of DC, slope of rising edge, and trigger level of 0.000pV.

The descriptions of **edge trigger** setting window is shown in the table below:

Menu	Settings	Descriptions
Type	Edge	Set the trigger type of the vertical channel to edge trigger.
Source	CH1	Set Channel 1 as the signal source trigger signal.

5. Use the Oscilloscope





	CH2 CH3 CH4	Set Channel 2 as the signal source trigger signal. Set Channel 3 as the signal source trigger signal. Set Channel 4 as the signal source trigger signal.
Coupling	DC AC HF	Set to allow all components to pass through. Set to block the DC components from passing through. Block the high-frequency signal from passing through and only allow low-frequency signal to pass through.
Slope	 	Set to trigger at the rising edge of the signal. Set to trigger at the falling edge of the signal.
Level	50%	Indicate the vertical trigger position of the channel, turn trigger level knob or slide your finger up and down to change the trigger level on the right side of the waveform display area of the screen; upon setting, a gray solid line will appear indicating the trigger level position and the trigger level value in the trigger information display box at the bottom edge of the screen will change accordingly. After the setting is completed, the solid line will disappear. Click 50% and set the shortcut key of trigger level in the vertical midpoint of the trigger signal amplitude.
HoldOff	100ns	100ns – 10s; click Numeric Input Box to input the interval to be set for restarting the trigger circuit and click the unit to confirm; or click Gear Input Box (- or +) or turn the General knob to set the interval for restarting the trigger circuit, and click < > or press  or  to move the cursor and select the digit to be set. Set the trigger hold-off time as 100ns.
Sensitivity		Set the sensitivity of the trigger window.
Mode	Auto Normal Single	Set to collect waveform even when no trigger condition is detected. Set to collect waveform only when trigger conditions are satisfied. Set to acquire a waveform when one trigger is detected and then stop acquisition.

Video Trigger

Select the **Video Trigger** to trigger on standard video signal field or line of **525i/NTSC, 625i/PAL** or **SECAM**. Enter the video trigger and the trigger setting

information is displayed in the lower part of the screen, such , indicating that the video trigger is selected with the trigger information source of CH1 and synchronization type of line.

The descriptions of **video trigger** setting window are shown in the table below:

Menu	Settings	Descriptions
Type	Video	Set the trigger type of the vertical channel to video trigger.
Source	CH1 CH2 CH3 CH4	Set Channel 1 as the signal source trigger signal. Set Channel 2 as the signal source trigger signal. Set Channel 3 as the signal source trigger signal. Set Channel 4 as the signal source trigger signal.
Standard	525i/NTSC 625i/PAL SECAM	Set the system standard of the video.
Sync	Line Field Odd Even Line NO.	Set to trigger the synchronization on the video line. Set to trigger the synchronization on the video field. Set to trigger the synchronization on the video odd field. Set to trigger the synchronization on the video even field. Set to trigger the synchronization on the specified video line; click Numeric Input Box to input the number of specified line to be set and click OK to confirm; or click Gear Input Box (- or +) or turn the General knob to set the number of specified line, and click < > or press  or  to move the cursor and select the digit to be set.
HoldOff	100ns	100ns – 10s; click Numeric Input Box to input the interval to be set for restarting the trigger circuit and click the unit to confirm; or click Gear Input Box (- or +) or turn the General knob to set the interval for restarting the trigger circuit, and click < > or press  or  to move the cursor and select the digit to be set. Set the trigger hold-off time as 100ns.
Mode	Auto Normal Single	Set to collect waveform even when no trigger condition is detected. Set to collect waveform only when trigger conditions are satisfied. Set to acquire a waveform when one trigger is





	detected and then stop acquisition.
--	-------------------------------------



Pulse Trigger

Pulse trigger is to determine the trigger moment based on the pulse width. You can discover abnormal pulse by setting the pulse width conditions. Enter the pulse trigger and the trigger setting information is displayed in the lower

part of the screen, such as , indicating that the pulse trigger is selected with the trigger signal source of CH1, polarity of positive pulse width and trigger level value of 1.000V.

The descriptions of **pulse width trigger** setting window are shown in the table below:

Menu	Settings	Descriptions
Type	Pulse	Set the trigger type of the vertical channel to pulse trigger.
Source	CH1 CH2 CH3 CH4	Set Channel 1 as the signal source trigger signal. Set Channel 2 as the signal source trigger signal. Set Channel 3 as the signal source trigger signal. Set Channel 4 as the signal source trigger signal.
Polarity		Select the polarity.
Time	> = < Time setting	Click  to set the pulse condition, click time setting's Numeric Input Box to input the pulse width time to be set and click the unit to confirm; or click Gear Input Box (- or +) or turn the General knob to set the pulse width time, and click < > or press  or  to move the cursor and select the digit to be set.
Threshold	50%	Click Numeric Display Box and turn General knob to set the lower threshold. Click 50% and set the shortcut key of trigger level in the vertical midpoint of the trigger signal amplitude.

HoldOff	100ns	100ns – 10s; click Numeric Input Box to input the interval to be set for restarting the trigger circuit and click the unit to confirm; or click Gear Input Box (- or +) or turn the General knob to set the interval for restarting the trigger circuit, and click < > or press  or  to move the cursor and select the digit to be set. Set the trigger hold-off time as 100ns.
Sensitivity		Set the sensitivity of the trigger window.
Mode	Auto Normal Single	Set to collect waveform even when no trigger condition is detected. Set to collect waveform only when trigger conditions are satisfied. Set to acquire a waveform when one trigger is detected and then stop acquisition.



Slope Trigger





Slope Trigger is to set the oscilloscope to trigger with the positive or negative slope at a specified time. Enter the slope trigger and the trigger setting information is displayed in the lower part of the screen, such as



, indicating that the slope trigger is selected with the trigger signal source of CH1, trigger condition of rising slope and 0.000pV of the difference between the upper threshold and the lower threshold.

The descriptions of **Slope Trigger** setting window are shown in the table below:

Menu	Settings	Descriptions
Type	Slope	Set the trigger type of the vertical channel to slope trigger.
Source	CH1 CH2 CH3 CH4	Set Channel 1 as the signal source trigger signal. Set Channel 2 as the signal source trigger signal. Set Channel 3 as the signal source trigger signal. Set Channel 4 as the signal source trigger signal.
Slope	 	Select the slope conditions.

Time	\gt $=$ \lt Time setting	Click  to set the slope conditions, click time setting's Numeric Input Box to input the slope time to be set and click the unit to confirm; or click Gear Input Box (- or +) or turn General knob to set the slope time, and click $\lt \gt$ or press  or  to move the cursor and select the digit to be set.
Upper Threshold	50%	Click Numeric Display Box and turn General knob to set the upper threshold; Click 50% and set the shortcut key of trigger level in the vertical midpoint of the trigger signal amplitude.
Lower Threshold	50%	Click Numeric Display Box and turn General knob to set the lower threshold; Click 50% and set the shortcut key of trigger level in the vertical midpoint of the trigger signal amplitude.
Slew Rate		$\text{Slope} = (\text{Upper Threshold} - \text{Lower Threshold}) / \text{Slope Trigger Time}$
HoldOff	100ns	100ns – 10s; click Numeric Input Box to input the interval to be set for restarting the trigger circuit and click the unit to confirm; or click Gear Input Box (- or +) or turn the General knob to set the interval for restarting the trigger circuit, and click $\lt \gt$ or press  or  to move the cursor and select the digit to be set. Set the trigger hold-off time as 100ns.
Mode	Auto Normal Single	Set to collect waveform even when no trigger condition is detected. Set to collect waveform only when trigger conditions are satisfied. Set to acquire a waveform when one trigger is detected and then stop acquisition.





Runt Trigger

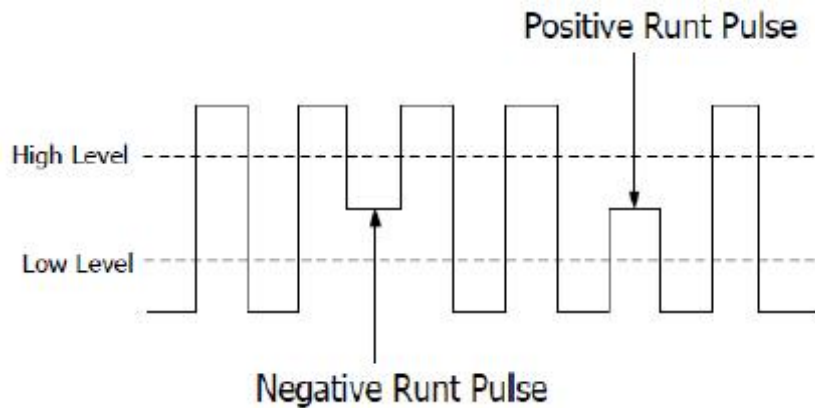

Used to trigger a pulse that steps over one trigger level but not another. Enter the runt trigger and the trigger setting information is displayed at the lower part

of the screen, such as , indicating that the runt trigger is selected with the trigger signal source of CH1, the polarity of positive runt and 0.000pV of the difference between upper level and lower level, as shown in the figure.



The descriptions of **runt trigger** setting window are shown in the table below:

Menu	Settings	Descriptions
Type	Runt	Set the trigger type of the vertical channel to under-amplitude trigger.
Source	CH1 CH2 CH3 CH4	Set Channel 1 as the signal source trigger signal. Set Channel 2 as the signal source trigger signal. Set Channel 3 as the signal source trigger signal. Set Channel 4 as the signal source trigger signal.
Polarity	 	Positive polarity, trigger on the positive under-amplitude pulse. Negative polarity, trigger on the negative under-amplitude pulse.
Time	Time setting > = <	Click  to set the pulse width conditions, click time setting's Numeric Input Box to input the pulse width to be set and click the unit to confirm; or click Gear Input Box (- or +) or turn General knob to set the pulse width, and click < > or press  or  to move the cursor and select the digit to be set. Trigger when runt pulse is greater than the set pulse width. Trigger when runt pulse equals to the set pulse width. Trigger when runt pulse is lower than the set pulse width.
Upper Threshold	50%	Click Numeric Display Box and turn General knob to set the upper threshold; Click 50% and set the shortcut key of trigger level in the vertical midpoint of the trigger signal amplitude.

Lower Threshold	50%	Click Numeric Display Box and turn General knob to set the lower threshold; Click 50% and set the shortcut key of trigger level in the vertical midpoint of the trigger signal amplitude.
HoldOff	100ns	100ns – 10s; click Numeric Input Box to input the interval to be set for restarting the trigger circuit and click the unit to confirm; or click Gear Input Box (- or +) or turn the General knob to set the interval for restarting the trigger circuit, and click < > or press  or  to move the cursor and select the digit to be set. Set the trigger hold-off time as 100ns.
Mode	Auto Normal Single	Set to collect waveform even when no trigger condition is detected. Set to collect waveform only when trigger conditions are satisfied. Set to acquire a waveform when one trigger is detected and then stop acquisition.







Windows Trigger

Provide a high trigger level and low trigger level, the oscilloscope triggers when the input signal passes through the high trigger level or the low trigger level. In Windows Trigger mode, the trigger setting information is displayed on

bottom right of the screen, for example, , indicates that trigger type is windows, trigger source is CH1, polarity is positive, 0.000pV the differential between up level and low level threshold.

The descriptions of **windows trigger** setting window are shown in the table below:

Menu	Settings	Descriptions
Type	Windows	Set vertical channel trigger type as Windows trigger.
Source	CH1 CH2 CH3 CH4	Set Channel 1 as the signal source trigger signal. Set Channel 2 as the signal source trigger signal. Set Channel 3 as the signal source trigger signal. Set Channel 4 as the signal source trigger signal.



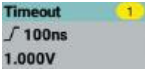

Polarity		Positive over-amplitude pulse .
		Negative over-amplitude pulse.
Conditions		Enter: Triggers when the trigger signal enters the specified trigger level range.
		Exit: Triggers when the trigger signal exits the specified trigger level range.
		Time: Specify the hold time of the input signal after entering the specified trigger level. The oscilloscope triggers when the accumulated hold time is greater than the windows time. Available range is 30ns-10s, default 100ns.
Upper Threshold	50%	Click Numeric Display Box and turn General knob to set the upper threshold; Click 50% and set the shortcut key of trigger level in the vertical midpoint of the trigger signal amplitude.
Lower Threshold	50%	Click Numeric Display Box and turn General knob to set the lower threshold; Click 50% and set the shortcut key of trigger level in the vertical midpoint of the trigger signal amplitude.
HoldOff		100ns – 10s; click Numeric Input Box to input the interval to be set for restarting the trigger circuit and click the unit to confirm; or click Gear Input Box (- or +) or turn the General knob to set the interval for restarting the trigger circuit, and click < > or press  or  to move the cursor and select the digit to be set.
		100ns Set the trigger hold-off time as 100ns.
Mode	Auto	Set to collect waveform even when no trigger condition is detected.
	Normal	Set to collect waveform only when trigger conditions are satisfied.
	Single	Set to acquire a waveform when one trigger is detected and then stop acquisition.

Timeout Trigger

Trigger when the interval from the time at which the rising (or falling) edge of the input signal passes through the touch level to the time when the adjacent falling (or rising) edge passes through the touch level is larger than the set

timeout period. Enter the timeout trigger and the trigger setting information is displayed at the lower part of the screen, such as , indicating that the timeout trigger type is selected with 0.000pV of the trigger level value.

The descriptions of **timeout trigger** setting window are shown in the table below:

Menu	Settings	Descriptions
Type	Timeout	Set the trigger type of the vertical channel as timeout trigger.
Source	CH1 CH2 CH3 CH4	Set Channel 1 as the signal source trigger signal. Set Channel 2 as the signal source trigger signal. Set Channel 3 as the signal source trigger signal. Set Channel 4 as the signal source trigger signal.
Slope	 	Set to start timing when the rising edge of the input signal passes through the trigger level. Set to start timing when the falling edge of the input signal passes through the trigger level.
Idle Time		Set the idle time. It refers to the minimum time that the clock signal must be in idle state before the oscilloscope begins to search for data that meets the trigger conditions. The idle time ranges from 30ns to 10s with default value of 100ns.
Threshold	50%	Click Numeric Display Box and turn General knob to set the lower threshold . Click 50% and set the shortcut key of trigger level in the vertical midpoint of the trigger signal amplitude.
HoldOff	100ns	100ns – 10s; click Numeric Input Box to input the interval to be set for restarting the trigger circuit and click the unit to confirm; or click Gear Input Box (- or +) or turn the General knob to set the interval for restarting the trigger circuit, and click < > or press  or  to move the cursor and select the digit to be set. Set the trigger hold-off time as 100ns.
Sensitivity		Set the sensitivity of the trigger window.

Mode	Auto	Set to collect waveform even when no trigger condition is detected.
	Normal	Set to collect waveform only when trigger conditions are satisfied.
	Single	Set to acquire a waveform when one trigger is detected and then stop acquisition.

Nth Edge Trigger

The oscilloscope triggers on the Nth edge that appears on the specified idle time. As figure shown below, the oscilloscope should trigger on the second falling edge after the specified idle time and the idle time should be set to $P1/P2/P3/P4 < \text{Idle Time} < M$. Wherein, M, P1, P2, P3 and P4 are positive or negative pulse width participating in the counting. In Nth Edge Trigger mode, the trigger setting information is displayed on bottom right of the screen, for example,





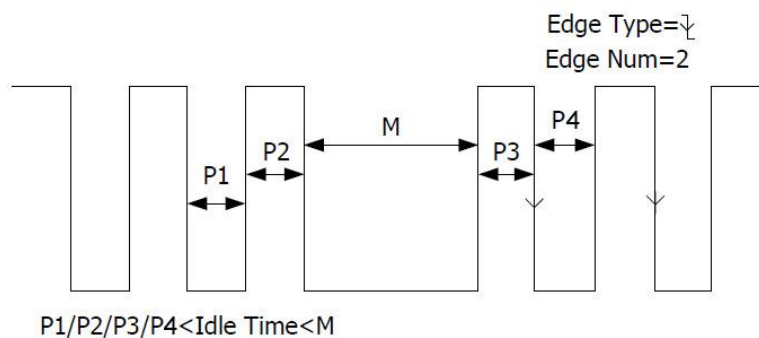





, indicates that trigger type is Nth Edge, trigger source is CH1, 0.000pV is up level or low level threshold.



The descriptions of the **Nth edge trigger** setting window are shown in the table below:

Menu	Settings	Descriptions
Type	Nth Edge	Set vertical channel trigger type as Nth Edge trigger.
Source	CH1	Set Channel 1 as the signal source trigger signal.
	CH2	Set Channel 2 as the signal source trigger signal.
	CH3	Set Channel 3 as the signal source trigger signal.
	CH4	Set Channel 4 as the signal source trigger signal.

5. Use the Oscilloscope

Slope	 	<p>Trigger on the rising edge of the input signal when voltage level meets the specified trigger level.</p> <p>Trigger on the falling edge of the input signal when voltage level meets the specified trigger level.</p>
Idle Time		<p>Set the time before starting the edge counting in the Nth edge trigger.</p> <p>Click Numeric Input Box to input the idle time to be set for restarting the trigger circuit and click the unit to confirm; or click Gear Input Box (- or +) or turn the General knob to set the idle time for restarting the trigger circuit, and click < > or press  or  to move the cursor and select the digit to be set.</p> <p>The time that can be set ranges from 30ns to 10s with default value of 100ns.</p>
Edge Num		<p>Set the specific value of N in the Nth edge trigger.</p> <p>Click Numeric Input Box to input the edge number to be set and click OK to confirm; or click Gear Input Box (- or +) or turn the General knob to set the edge number, and click < > or press  or  to move the cursor and select the digit to be set.</p>
Threshold	50%	<p>Click Numeric Display Box and turn General knob to set the required threshold.</p> <p>Click 50% and set the shortcut key of trigger level in the vertical midpoint of the trigger signal amplitude.</p>
HoldOff	100ns	<p>100ns – 10s; click Numeric Input Box to input the interval to be set for restarting the trigger circuit and click the unit to confirm; or click Gear Input Box (- or +) or turn the General knob to set the interval for restarting the trigger circuit, and click < > or press  or  to move the cursor and select the digit to be set.</p> <p>Set the trigger hold-off time as 100ns.</p>
Sensitivity		Set the sensitivity of the trigger window.
Mode	Auto Normal Single	<p>Set to collect waveform even when no trigger condition is detected.</p> <p>Set to collect waveform only when trigger conditions are satisfied.</p> <p>Set to acquire a waveform when one trigger is detected and then stop acquisition.</p>

Logic Trigger



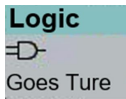









Determine the trigger conditions with the logical relations. Enter the logic trigger and the trigger setting information is displayed at the lower part of the screen,





such as **Logic**  **Goes True**, indicating that the logic trigger type is selected with the logic mode of AND, input mode of high level and output mode of Goes True.

Note: When a rising or falling edge is set for one channel, it can not do the same for another.

The descriptions of the **Logic trigger** setting window are shown in the table below:

Menu	Settings	Descriptions
Type	Logic	Set vertical channel trigger type as Logic trigger.
Logic Mode	AND  OR  XOR  XNOR 	Set logic mode as AND. Set logic mode as OR. Set logic mode as XOR. Set logic mode as XNOR.
CH1 Input Mode	1 0 X  	Set CH1 as High Level, Low level, high or low level, Rise and Fall.
CH2 Input Mode	1 0 X  	Set CH2 as High Level, Low level, high or low level, Rise and Fall.
CH3 Input Mode	1 0 X  	Set CH3 as High Level, Low level, high or low level, Rise and Fall.
CH4 Input Mode	1 0 X  	Set CH4 as High Level, Low level, high or low level, Rise and Fall.

5. Use the Oscilloscope

Output Mode	GoesTrue GoesFalse True> True= True<	<p>Click  to select the output mode.</p> <p>GoseTrue: Trigger when condition turns True from False.</p> <p>GoseFalse: Trigger when condition turns False from True.</p> <p>True >: Trigger when the time of true condition is more than the set time.</p> <p>True =: Trigger when the time of true condition is equal to the set time.</p> <p>True <: Trigger when the time of true condition is lower than the set time.</p>
CH1 Threshold	50%	<p>Click Numeric Display Box and turn General knob to set the CH1 Threshold.</p> <p>Click 50% and set the shortcut key of trigger level in the vertical midpoint of the trigger signal amplitude.</p>
CH2 Threshold	50%	<p>Click Numeric Display Box and turn General knob to set the CH2 Threshold.</p> <p>Click 50% and set the shortcut key of trigger level in the vertical midpoint of the trigger signal amplitude.</p>
CH3 Threshold	50%	<p>Click Numeric Display Box and turn General knob to set the CH3 Threshold.</p> <p>Click 50% and set the shortcut key of trigger level in the vertical midpoint of the trigger signal amplitude.</p>
CH4 Threshold	50%	<p>Click Numeric Display Box and turn General knob to set the CH4 Threshold.</p> <p>Click 50% and set the shortcut key of trigger level in the vertical midpoint of the trigger signal amplitude.</p>
HoldOff	100ns	<p>100ns – 10s; click Numeric Input Box to input the interval to be set for restarting the trigger circuit and click the unit to confirm; or click Gear Input Box (- or +) or turn the General knob to set the interval for restarting the trigger circuit, and click < > or press  or  to move the cursor and select the digit to be set.</p> <p>Set the trigger hold-off time as 100ns.</p>
Sensitivity		Set the sensitivity of the trigger window.

Mode	Auto	Set to collect waveform even when no trigger condition is detected.
	Normal	Set to collect waveform only when trigger conditions are satisfied.
	Single	Set to acquire a waveform when one trigger is detected and then stop acquisition.

RS232/UART Trigger

RS232/UART bus is a serial data communication mode used for data transmission between computers or between the computer and the terminal. RS232 serial protocol transmit a character as a frame of data, the frame structure is composed of 1 start bit, 5-8 data bits, 1 check bit and 1-2 stop bit(s), with the format as shown in the figure below. It is triggered when a start frame, error frame, check error or specified data is detected.



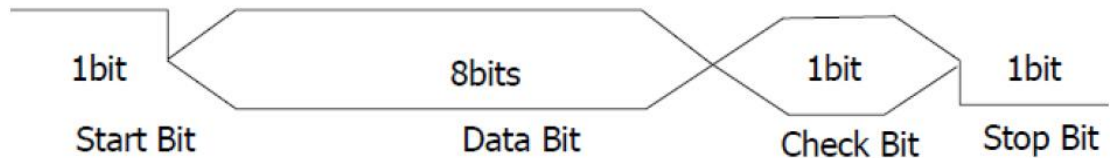

Enter the RS232/UART bus trigger and the trigger setting information is displayed at the lower part of the screen, such as , indicating that the RS232/UART trigger mode is selected with the trigger signal source of CH1, CH1 baud rate of 9,600bps and CH1 trigger level of 0.000pV.



The descriptions of **RS232 trigger** setting window are shown in the table below:

Menu	Settings	Descriptions
Type	RS232/ UART	Set the buss trigger type to RS232/UART trigger.
Source	CH1 CH2 CH3 CH4	Set Channel 1 as the signal source trigger signal. Set Channel 2 as the signal source trigger signal. Set Channel 3 as the signal source trigger signal. Set Channel 4 as the signal source trigger signal.
Polarity		Select positive polarity for data transmission.

5. Use the Oscilloscope

		Select reverse polarity for data transmission.
Baud	Common	Click Numeric Display Box and turn General knob to set the commonly-used baud rate.
	Custom	Click Numeric Display Box to input the baud rate to be set and click unit to confirm; or click Gear Input Box (- or +) or turn the General knob to set the baud rate, and click < > or press  or  to move the cursor and select the digit to be set. The baud rate ranges from 50 to 10,000,000.
Threshold	50%	Click Numeric Display Box and turn General knob to set the required threshold. Click 50% and set the shortcut key of trigger level in the vertical midpoint of the trigger signal amplitude.
Condition	Start	Trigger when a start frame is detected, and set after selecting this trigger condition: Stop Bit: Select “1 bit” or “2 bits”. Parity Check: “N/A” refers to no check; “Even” refers to even check and “Odd” refers to odd check.
	Error	Trigger when an error frame is detected, and set after selecting this trigger condition: Stop Bit: Select “1 bit” or “2 bits”. Parity Check: “N/A” refers to no check; “Even” refers to even check and “Odd” refers to odd check; the oscilloscope determines if there is any check error based on this setting.
	Chk Error	Trigger when a check error is detected. After selecting this trigger conditions, click Parity Check to select even check or odd check.
	Data	Trigger at the last bit of the set data bit and set after selecting this trigger condition: Data Bit Width: Set to 5, 6, 7, or 8 bits. Data: Based on the set data bit width, the data range is between 0 and 2 data bits width power -1.
HoldOff	100ns	100ns – 10s; click Numeric Input Box to input the interval to be set for restarting the trigger circuit and click the unit to confirm; or click Gear Input Box (- or +) or turn the General knob to set the interval for restarting the trigger circuit, and click < > or press  or  to move the cursor and select the digit to be set. Set the trigger hold-off time as 100ns.

Sensitivity		Set the sensitivity of the trigger window.
Mode	Auto	Set to collect waveform even when no trigger condition is detected.
	Normal	Set to collect waveform only when trigger conditions are satisfied.
	Single	Set to acquire a waveform when one trigger is detected and then stop acquisition.

I2C Trigger

I2C serial bus consists of two lines, SCL and SDA, with the transmission rate determined by the clock line SCL and transmission data by SDA, as shown in the figure, it can be triggered upon start, restart, stop, loss confirmation and specific equipment address or data value.

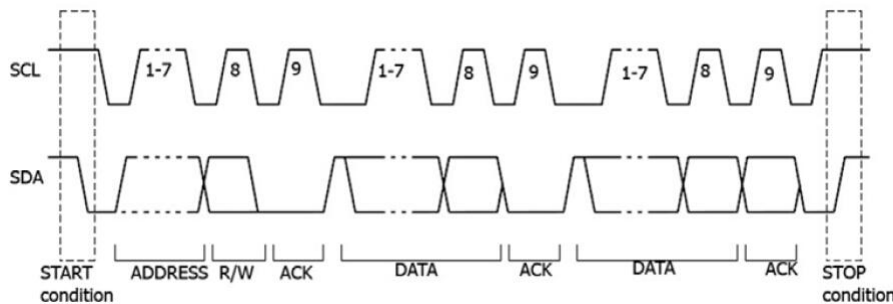

Enter the I2C bus trigger and the trigger setting information is displayed at the lower part of the screen, such as , indicating that the I2C trigger type is selected with CH1 SCL trigger level of 400.0mV and CH2 SDA trigger level of 464.0mV.



The descriptions of the **I2C trigger** setting window are as follows:

Menu	Settings	Descriptions
Type	I2C	Set the bus trigger type to I2C.
SCL	CH1	Set Channel 1 as SCL.
	CH2	Set Channel 2 as SCL.
	CH3	Set Channel 3 as SCL.
	CH4	Set Channel 4 as SCL.
Threshold	50%	Click Numeric Display Box and turn General knob to set the SCL threshold. Click 50% and set the shortcut key of trigger level in the vertical midpoint of the trigger signal amplitude.

5. Use the Oscilloscope

SDA	CH1 CH2 CH3 CH4	Set Channel 1 as SDA. Set Channel 2 as SDA. Set Channel 3 as SDA. Set Channel 4 as SDA.	
Threshold	50%	Click Numeric Display Box and turn General knob to set the SDA threshold . Click 50% and set the shortcut key of trigger level in the vertical midpoint of the trigger signal amplitude.	
Condition	Start	Trigger when SCL is in high level and SDA is from high level to low level.	
	Restart	Trigger when another starting condition occurs before the stopping condition.	
	Stop	Trigger when SCL is in high level and SDA is from low level to high level.	
	Ack Lost	Trigger when SDA data is in high level during any SCL clock bit period.	
	A d d r		Trigger to search for the address value set on the read/write bit.
		Addr Bits	Set the address bit width to “7-bit”, “8-bit” or “10-bit”.
		Addr	The address ranges from 0 to 127, from 0 to 255 and from 0 to 1023 depending on the address bit width.
		Direction	Set the data direction to read or write. Note: This setting is not available when the address bit width is 8.
	D a t a		Search for the set data value on the data line and trigger on the edge of the last clock line in the data.
		Byte Length	Set the byte length of the data ranging from 1 byte to 5 bytes. Turn General knob to set it.
Data		Set the data code type on current data bit.	
	Addr/Data	Search for the set address value and data value simultaneously and trigger when both meet the trigger conditions; for specific settings, refer to the setting of address format and data format.	
HoldOff		100ns – 10s; click Numeric Input Box to input the interval to be set for restarting the trigger circuit and click the unit to confirm; or click Gear Input Box (- or +) or turn the General knob to set the interval for restarting the trigger circuit, and click < > or press  or  to move the	

5. Use the Oscilloscope

	100ns	cursor and select the digit to be set. Set the trigger hold-off time as 100ns.
Sensitivity		Set the sensitivity of the trigger window.
Mode	Auto	Set to collect waveform even when no trigger condition is detected.
	Normal	Set to collect waveform only when trigger conditions are satisfied.
	Single	Set to acquire a waveform when one trigger is detected and then stop acquisition.

SPI Trigger

Trigger when the timeout conditions are met and the specified data is found by the oscilloscope. In SPI trigger mode, it is required to specified SCL (Serial Clock Line) and SDA (Serial Clock Data).









Enter the SPI bus trigger and the trigger setting information is displayed at

the lower part of the screen, such as , indicating that the SPI trigger mode is selected with the CH1 SCL trigger level of 400.0V and CH2 SDA trigger level of 466.0mV.

The descriptions of **SPI Trigger** setting window are as follows:

Menu	Settings	Descriptions
Type	SPI	Set the trigger type of the vertical channel to SPI trigger.
SCL	CH1 CH2 CH3 CH4	Set Channel 1 as the SCL mode. Set Channel 2 as the SCL mode. Set Channel 3 as the SCL mode. Set Channel 4 as the SCL mode.
Threshold	50%	Click Numeric Display Box and turn General knob to set the SCL threshold. Click 50% and set the shortcut key of trigger level in the vertical midpoint of the trigger signal amplitude.
SDA	CH1 CH2 CH3 CH4	Set Channel 1 as the SDA mode. Set Channel 2 as the SDA mode. Set Channel 3 as the SDA mode. Set Channel 4 as the SDA mode.
Threshold	50%	Click Numeric Display Box and turn General knob to set the SDA threshold. Click 50% and set the shortcut key of trigger level in

5. Use the Oscilloscope

		the vertical midpoint of the trigger signal amplitude.
Timeout		Set the minimum idle period that is, one SCL cycle ranging from 30ns to 10s with default value of 100ns. Timeout occurs when the SDA meeting the trigger conditions is found by the oscilloscope after the SCL signal remains idle for a specified time; Click Numeric Input Box to input the timeout period to be set and click the unit to confirm; or click Gear Input Box (- or +) or turn General knob to set the timeout period, click < > or press   to move the cursor and select the digit to be set. For idle state value, press   to move the cursor and select the digit to be set.
Clock Edge	 	Set the clock edge to rising edge or falling edge. The rising edge refers to acquire the SDA at the rising edge of the clock; the falling edge refers to acquire the SDA at the falling edge of the clock.
Data Bits		Set the number of bits in the serial data string ranging from 4 to 32 bits; click Numeric Display Box and turn General Knob to set the data bit width.
Data		Set the data bit.
HoldOff		100ns – 10s; click Numeric Input Box to input the interval to be set for restarting the trigger circuit and click the unit to confirm; or click Gear Input Box (- or +) or turn the General knob to set the interval for restarting the trigger circuit, and click < > or press  or  to move the cursor and select the digit to be set.
	100ns	Set the trigger hold-off time as 100ns.
Sensitivity		Set the sensitivity of the trigger window.
Mode	Auto	Set to collect waveform even when no trigger condition is detected.
	Normal	Set to collect waveform only when trigger conditions are satisfied.
	Single	Set to acquire a waveform when one trigger is detected and then stop acquisition.

CAN Trigger

CAN, the abbreviation of Controller Area Network, is the serial communication protocol of ISO international standardization.



In CAN bus trigger mode, it can be triggered upon **Start** , **Type**, **ID**, **Data**, **ID/Data**, **End**, **Lost** or **Error**. It is required to specify the signal source, signal

type, acquisition point and signal rate.



Enter the CAN bus trigger and the trigger setting information is displayed

at the lower right of the screen, such as , indicating that the CAN trigger type is selected with the trigger signal source of CH1, frame type of CAN_H and the baud rate of 1,000,000bps.



The descriptions of **CAN trigger** setting window are as follows:

Menu	Settings	Descriptions
Type	CAN	Set the bus trigger type as CAN.
Source	CH1 CH2 CH3 CH4	Set Channel 1 as the signal source trigger signal. Set Channel 2 as the signal source trigger signal. Set Channel 3 as the signal source trigger signal. Set Channel 4 as the signal source trigger signal.
Type	CAN_H CAN_L TX RX DIFF	Actual CAN_H bus signal. Actual CAN_L bus signal. Sending signal from CAN signal line. Receiving signal from CAN signal line. Use a differential probe to connect to the analog channel's CAN differential bus signal. Connect the positive terminal of the differential probe to the CAN_H bus signal, and the negative terminal to the CAN_L bus signal.
Sample Point		Click Numeric Input Box to input the point within the bit time to be set and click % to confirm; or click Gear Input Box (- or +) or turn General knob to set the point within the bit time, click < > or press   to move the cursor and select the digit to be set. The oscilloscope start acquisition to bit level at this point. The position of acquisition point is indicated with the percentage of "bit start to acquisition point" to "bit time", ranging from 0.5% to 95%.
Baud	Common	Click Numeric Display Box and turn General knob to select the baud rate from the table.

5. Use the Oscilloscope

	Custom	Click Numeric Display Box to input the baud rate to be set and click the unit to confirm; or click Gear Input Box (- or +) or turn the General knob to set the baud rate, and click < > or press  or  to move the cursor and select the digit to be set. Set the baud rate ranging from 10,000 to 1,000,000.		
Threshold	50%	Click Numeric Display Box and turn General knob to set the required threshold. Click 50% and set the shortcut key of trigger level in the vertical midpoint of the trigger signal amplitude.		
Condition	Start	Trigger at the frame start bit of the data frame.		
	Type	Type	Data	Trigger on the selected frame type.
			Remote	
			Error	
			Overload	
	ID	ID Format	Standard	Select the ID format as standard or extended.
			Extend	
		ID Value	Use the General knob and arrow keys on the panel to set the ID value required.	
	Data	Byte Length	Click Numeric Display Box and select the byte length required for the set data, ranging from 1 to 8.	
		Data	Use the General knob and arrow keys on the panel to set the value required for the data.	
ID /Data	ID Format	Standard	Select the ID format as standard or extended.	
		Extend		
		ID Value	Use the General knob and arrow keys on the panel to set the ID value required.	
		Byte Length	Click Numeric Display Box and select the byte length required for the set data, ranging from 1 to 8.	
	Data	Use the General knob and arrow keys on the panel to set the value required for the data.		
End	Trigger at the frame end bit of the data frame.			
Lost	Set the trigger condition to loss confirmation.			

5. Use the Oscilloscope

	Error	Set the trigger condition to padding error.
HoldOff		100ns – 10s; click Numeric Input Box to input the interval to be set for restarting the trigger circuit and click the unit to confirm; or click Gear Input Box (- or +) or turn the General knob to set the interval for restarting the trigger circuit, and click < > or press  or  to move the cursor and select the digit to be set.
	100ns	Set the trigger hold-off time as 100ns.
Sensitivity		Set the sensitivity of the trigger window.
Mode	Auto	Set to collect waveform even when no trigger condition is detected.
	Normal	Set to collect waveform only when trigger conditions are satisfied.
	Single	Set to acquire a waveform when one trigger is detected and then stop acquisition.

LIN Trigger

The LIN bus data frame format is shown in the figure below:

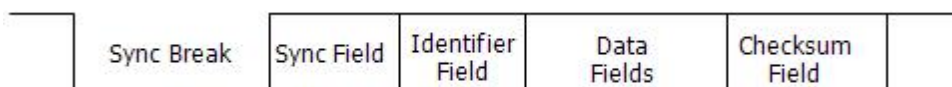

Trigger with LIN bus based on signal **Break, ID, ID/data** and **Data Error**.

The signal source and signal rate specified by LIN is required.





Enter the LIN buss trigger and the trigger setting information is displayed

at the lower right of the screen, such as , indicating that the LIN trigger type is selected with the trigger signal source of CH1, baud rate of 1,200bps and trigger level of 1.800V.

The descriptions of **LIN trigger** setting window are as follows:

Menu	Settings	Descriptions
Type	LIN	Set the buss trigger type as LIN.
Source	CH1	Set Channel 1 as the signal source trigger signal.
	CH2	Set Channel 2 as the signal source trigger signal.
	CH3	Set Channel 3 as the signal source trigger signal.
	CH4	Set Channel 4 as the signal source trigger signal.
Baud	Commo n	Click Numeric Display Box and turn General knob to select the baud rate from the table.

5. Use the Oscilloscope

	Custom	Click Numeric Display Box to input the baud rate to be set and click the unit to confirm; or click Gear Input Box (- or +) or turn the General knob to set the baud rate, and click < > or press  or  to move the cursor and select the digit to be set. Set the baud rate ranging from 50bps to 20kbps.		
Threshold	50%	Click Numeric Display Box and turn General knob to set the required threshold. Click 50% and set the shortcut key of trigger level in the vertical midpoint of the trigger signal amplitude.		
Condition	Break	Trigger at the frame start bit of the data frame.		
	ID/Data	ID	Use General knob and arrow keys on the panel to set the ID valued required.	
		Byte Length	ID	Use General knob and arrow keys on the panel to set the ID valued required.
			Data	Use the General knob to specify the length of the data in bytes, ranging from 1 to 8.
	Data Error	Set the trigger condition to bit data error.		
HoldOff	100ns	100ns – 10s; click Numeric Input Box to input the interval to be set for restarting the trigger circuit and click the unit to confirm; or click Gear Input Box (- or +) or turn the General knob to set the interval for restarting the trigger circuit, and click < > or press  or  to move the cursor and select the digit to be set. Set the trigger hold-off time as 100ns.		
Sensitivity		Set the sensitivity of the trigger window.		
Mode	Auto	Set to collect waveform even when no trigger condition is detected.		
	Normal	Set to collect waveform only when trigger conditions are satisfied.		
	Single	Set to acquire a waveform when one trigger is detected and then stop acquisition.		

How To Set Analysis Modulation

Analysis modulation including: Measure, XY Mode, Cursor, Math, FFT, DIR, Pass Fail, Counter, DVM, Decode and Record.

How To Set Automatic Measurement

Press **Measure** key or click  and select **Measure** menu to conduct automatic measurement; there are 43 kinds of measurement including horizontal measurement, vertical measurement, Blend measurement and Inter-CH measurement, and a maximum of 8 measuring types can be displayed at the lower left of the screen.

Horizontal Measurement includes: Period, + Width, Rise Time, +Duty, Frequency, - Width, Fall Time, -Duty and ScrDuty;

Vertical Measurement includes: Vavg, Vpp, Vamp, StdDev, Vmax, Vtop, VRMS, Overshoot, Vmin, Vbase, CycRms and Preshoot;

Blend Measurement includes: +PulseCnt, -PulseCnt, RiseCnt, FallCnt, Area and CycArea;

Inter-channel Measurement includes: Delay(1 Ψ -2 Ψ), Delay(1 Ψ -2 Ψ), Delay(1 Ψ -2 Ψ), Delay(1 Ψ -2 Ψ), Phase(1 Ψ -2 Ψ), Phase(1 Ψ -2 Ψ), Phase(1 Ψ -2 Ψ), Phase(1 Ψ -2 Ψ), FRR(1 Ψ -2 Ψ), FRF(1 Ψ -2 Ψ), FFR(1 Ψ -2 Ψ), FFF(1 Ψ -2 Ψ), LRR(1 Ψ -2 Ψ), LRF(1 Ψ -2 Ψ), LFR(1 Ψ -2 Ψ) and LFF(1 Ψ -2 Ψ).

The descriptions of automatic measurement setting window is shown as follows:

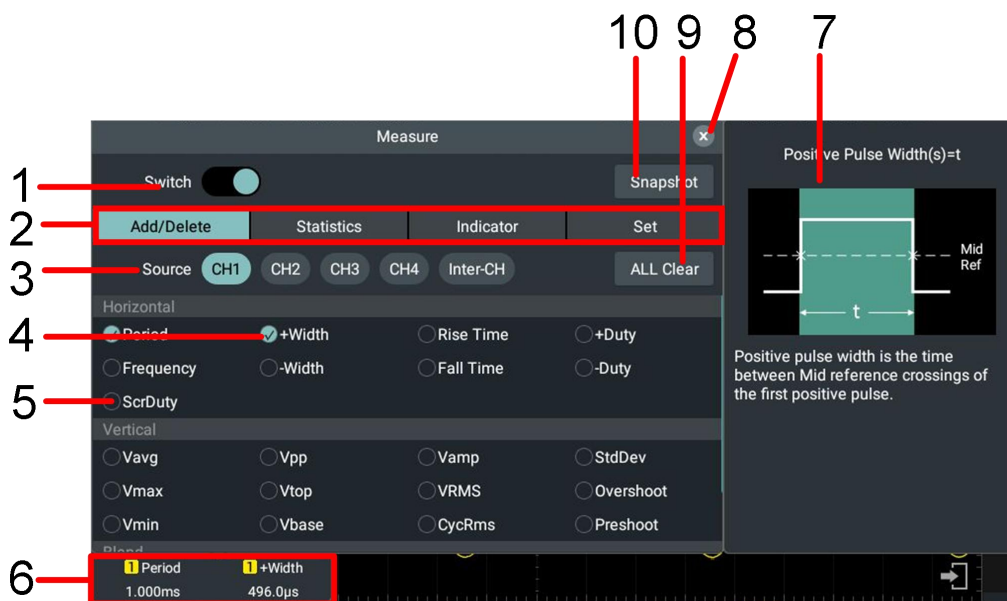

Figure 5-5:Automatic measurement

Num	Descriptions
1	Switch, the current state is On; and the measurement is off when the circle is gray.
2	Setting measuring menu.
3	Select signal source CH1, CH2, CH3 and CH4 or between channels. Select the corresponding signal source to highlight the signal source and display corresponding measuring type. Current state is CH1 signal source being selected.
4	It indicates that the current measuring type is added.
5	It indicates that the current measuring type is not added.
6	It indicates the display box of current measuring value type and measuring result display box.
7	The currently selected measurement type is interpreted.
8	Click to close measuring menu.
9	Click to delete all added measuring types.
10	Click to display all measuring values of current opened channel.

Add/Delete

The waveform channel must be opened for measurement. Automatic measurement can not be performed when storing the waveform or calculating double waveforms. In slow sweep, both the cycle and frequency can not be measured.

For example: To measure the cycle and +Width of CH1 channel signal, operate according to the following steps:

1. Press **Measure** key and the setting window is displayed on the screen.
2. Click the **Switch** to On state and the circle is highlighted.
3. Click Signal Source **CH1** to highlight it.
4. Click **Period** and **+Width** in the horizontal measurement, and the circle is checked and highlighted.

The measured values will be automatically displayed at the lower left of

the screen. See Number 6 in Figure 5-5.

Automatic Measurement of Horizontal Parameters

The oscilloscopes provide time parameters auto-measurements include Period, Frequency, Rise Time, Fall Time, +Width, -Width, +Duty, -Duty, and ScrDuty.

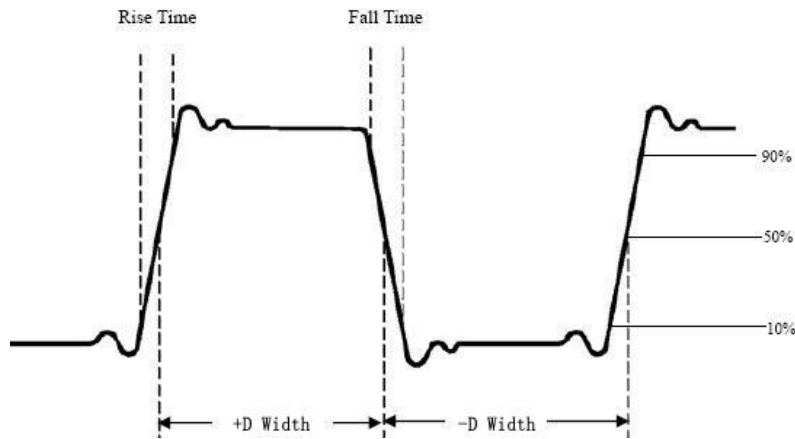

Figure 5-6

Rise Time: Time that the leading edge of the first pulse in the waveform takes to rise from 10% to 90% of its amplitude.

Fall Time: Time that the falling edge of the first pulse in the waveform takes to fall from 90% to 10% of its amplitude.

+Width: The width of the first positive pulse in 50% amplitude points.

-Width: The width of the first negative pulse in the 50% amplitude points.

+Duty: +Duty Cycle, defined as +Width/Period.

-Duty: -Duty Cycle, defined as -Width/Period.

ScrDuty: Defines as (the width of the positive pulse)/(Entire period).

Automatic Measurement of Vertical Parameters

The oscilloscopes provide automatic voltage measurements including Vavg, Vpp, Vamp, StdDev, Vmax, Vtop, VRMS, Overshoot, Vmin, Vbase, CycRms and Preshoot. The following figure illustrates the physical significance of a set of voltage parameters.

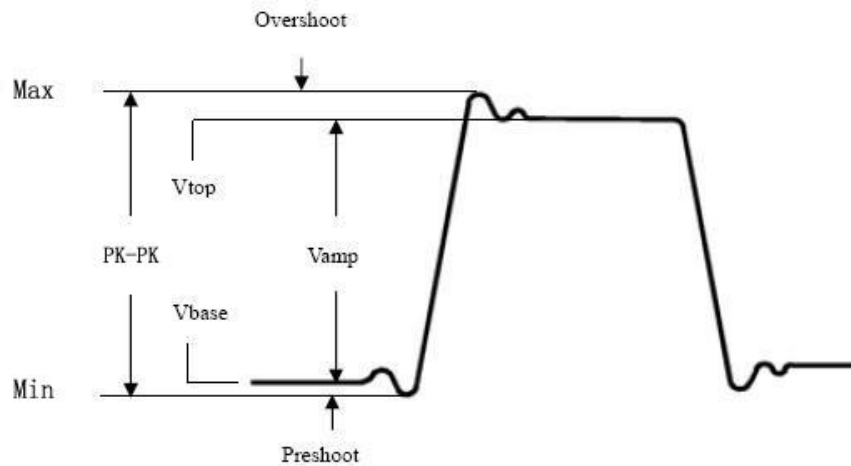

Figure 5-7

Vavg: The arithmetic mean over the entire waveform.

Vpp: Peak-to-Peak Voltage.

VRMS: The true Root Mean Square voltage over the entire waveform.

Overshoot: Defined as $(V_{max}-V_{top})/V_{amp}$, useful for square and pulse waveforms.

Vmax: The maximum amplitude. The most positive peak voltage measured over the entire waveform.

Vmin: The minimum amplitude. The most negative peak voltage measured over the entire waveform.

Vtop: Voltage of the waveform's flat top, useful for square/pulse waveforms.

CycRms: The true Root Mean Square voltage over the first entire period of the waveform.

Vbase: Voltage of the waveform's flat base, useful for square/pulse waveforms.

Vamp: Voltage between Vtop and Vbase of a waveform.

Preshoot: Defined as $(V_{min}-V_{base})/V_{amp}$, useful for square and pulse waveforms.

StdDev: Calculate the arithmetic square root of the mean of the square of the difference between each data piece of the waveform and its mean.

Blend Measurement

+PulseCnt : The number of positive pulses that rise above the mid reference crossing in the waveform.

-PulseCnt : The number of negative pulses that fall below the mid reference crossing in the waveform.

RiseCnt : The number of positive transitions from the low reference value to the high reference value in the waveform.

FallCnt : The number of negative transitions from the high reference value to the low reference value in the waveform.

Area : The area of the whole waveform within the screen and the unit is voltage-second. The area measured above the zero reference (namely the vertical offset) is positive; the area measured below the zero reference is negative. The area measured is the algebraic sum of the area of the whole waveform within the screen.

CycArea : The area of the first period of waveform on the screen and the unit is voltage-second. The area above the zero reference (namely the vertical offset) is positive and the area below the zero reference is negative. The area measured is the algebraic sum of the area of the whole period waveform.

Note: When the waveform on the screen is less than a period, the period area measured is 0.

Automatic Measurement of Inter-channel Parameters

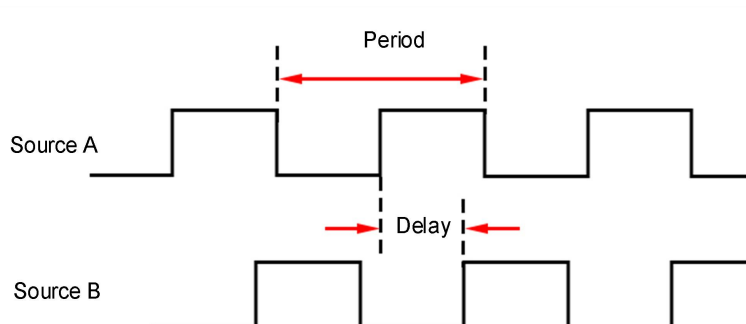

Note for the following measurements:

When source A in the menu is set to CH<n>, source A is CH<n>.

When source B in the menu is set to CH<n>, source B is CH<n>.

Delay(\uparrow - \uparrow): The time difference between the rising edge of source A and the rising edge of source B at the middle of the threshold. Negative delay indicates that the rising edge of source A occurs after that of source B.

Delay (\downarrow - \downarrow): The time difference between the falling edge of source A and the falling edge of source B at the middle of the threshold. Negative delay indicates that the falling edge of source A occurs after that of source B.

Delay(\uparrow - \downarrow): The time difference between the rising edge of source A and the falling edge of source B at the middle of the threshold. Negative delay indicates that the rising edge of source A occurs after the falling edge of source B.

Delay(\downarrow - \uparrow): The time difference between the lower rising edge of source A and the upper falling edge of source B at the middle value of the threshold. Negative delay indicates that the lower rising edge of source A occurs after the upper falling edge of source B.

Phase(\uparrow - \uparrow): The phase difference between the rising edge of source A and the rising edge of source B at the middle value of the threshold is expressed in degrees. Calculation formula is:

$$Phase_{A_R B_R} = \frac{Delay_{A_R B_R}}{Period_{sourceA}} \times 360^\circ$$

Of which, $Phase_{A_R B_R}$ is phase(\uparrow - \uparrow), $Delay_{A_R B_R}$ is delay(\uparrow - \uparrow),

$Period_{sourceA}$ is source A period.

Phase(\downarrow - \downarrow): The phase difference between the falling edge of source A and the falling edge of source B at the middle value of the threshold is expressed in degrees. Calculation formula is:

$$Phase_{A_F B_F} = \frac{Delay_{A_F B_F}}{Period_{sourceA}} \times 360^\circ$$

Of which, $Phase_{A_F B_F}$ is phase($\Psi - \Phi$), $Delay_{A_F B_F}$ is delay($\Psi - \Phi$), $Period_{sourceA}$ is source A period.

Phase($\Phi - \Psi$): The phase difference between the rising edge of source A and the falling edge of source B at the middle value of the threshold is expressed in degrees. Calculation formula is:

$$Phase_{A_R B_F} = \frac{Delay_{A_R B_F}}{Period_{sourceA}} \times 360^\circ$$

Of which, $Phase_{A_R B_F}$ is phase($\Phi - \Psi$), $Delay_{A_R B_F}$ is delay($\Phi - \Psi$), $Period_{sourceA}$ is source A period.

Phase($\Psi - \Phi$): The phase difference between the falling edge of source A and the rising edge of source B at the middle value of the threshold is expressed in degrees. Calculation formula is:

$$Phase_{A_F B_R} = \frac{Delay_{A_F B_R}}{Period_{sourceA}} \times 360^\circ$$

Of which, $Phase_{A_F B_R}$ is phase($\Psi - \Phi$), $Delay_{A_F B_R}$ is delay($\Psi - \Phi$), $Period_{sourceA}$ is source A period.

FRR: Time between Source A first rising edge and Source B first rising edge.

FRF: Time between Source A first rising edge and Source B first falling edge.

FFR: Time between Source A first falling edge and Source B first rising edge.

FFF: Time between Source A first falling edge and Source B first falling edge.

LRR: Time between Source A first rising edge and Source B last rising edge.

LRF: Time between Source A first rising edge and Source B last falling edge.

LFR: Time between Source A first falling edge and Source B last rising edge.

LFF: Time between Source A first falling edge and Source B last falling edge.

Statistics

Click **Statistics** in the setting window, as shown below.



- Click switch to open or close the statistics display window. This instrument supports statistics and displays the current value of a number of measurement results, as shown in the figure below.



	1 Period
Cur:	1.000ms
Avg:	999.3us
Max:	1.440ms
Min:	998.6us
Dev:	666.6ns

- Click **Avg & Std Sample Times** Input Box, set the statistics number by pop up keyboard and also can rotate the corresponding multipurpose knob to set value. The value range of measurement times is 2 to 1000, default is 2.
- Click **Reset**, it will clear all measurement of history data and statistics again.

Indicator

In the Indicator setting window, click **Switch**, select open or close Indicator function.

If opening Indicator function, screen will appear one or multiple cursor. Before opening Indicator function, you need to open one automatic measurement parameter at least, cursor number will change by measurement parameters.

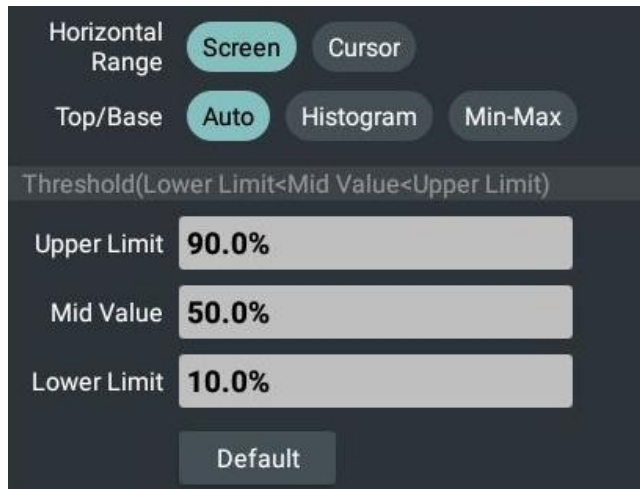
Set

Horizontal Range: Selecting **Screen** indicates that the measurement range is the whole screen; selecting **Cursor** indicates that the measurement range is only within the cursor range.

Top/Base: Set the measurement method for the top and bottom values of the amplitude. Can choose **Auto**, **Histogram** or **Min-Max**.

Threshold (Lower Limit<Mid Value<Upper Limit):

- Click **Upper Limit** Input Box set the statistics number by pop up keyboard and also can rotate the corresponding general knob to set value. When the upper limit value is set to less than or equal to the current median value, the interface prompts "exceed the limit value", and the instrument automatically adjusts the upper limit value to make it higher than the median value. The default percentage is 90%, and the default absolute value changes with the vertical setting of the channel.
- Click **Mid Value** Input Box set the statistics number by pop up keyboard and also can rotate the corresponding general knob to set value. The median value is limited by the upper and lower limits, and the default percentage is 50%. The default absolute value varies with the vertical setting of the channel.
- Click **Lower Limit** Input Box set the statistics number by pop up

keyboard and also can rotate the corresponding general knob to set value. When the current limit value is set to greater than or equal to the current median value, the interface prompts "exceed limit value", and the instrument automatically adjusts the lower limit value to make it lower than the median value. The default percentage is 10% and the default absolute value changes with the vertical setting of the channel.

- Click **Default** The instrument restores the upper limit, med value, and lower limit to default values.

How To Set XY Mode

After XY mode is selected, both Channel 1 and Channel 2 are opened and one waveform amplitude is displayed relative to another. **CH1** is displayed on the horizontal axis and **CH2** is displayed on the vertical axis.

Horizontal axis can select CH1, CH2, CH3 or CH4.

Vertical axis can select CH1, CH2, CH3 or CH4.

Operations of various control buttons are as follows:

- Use **Vertical Scale** and **Vertical Position** knob to set the scale and position in horizontal direction.
- Use **Vertical Scale** and **Vertical Position** knob to set the scale and position in vertical direction.

In the XY mode, the following functions are not available:

- Mathematical operation waveform
- FFT
- DIR
- Pass/Fail

Operating Steps:

(1) Click the main menu window  , select **XY Mode**. Then click **Switch** to highlight it.

(2) Select **Full Screen** to **On** status to open the full screen view of XY

mode.

How To Set Cursor Measurement

Press **Cursor** key, click the main menu window to select **Cursor** option or click **Cursor Shortcut** at the upper part of the screen and then click the information display bar in the right of the screen, the cursor information display bar as shown in the figure below.

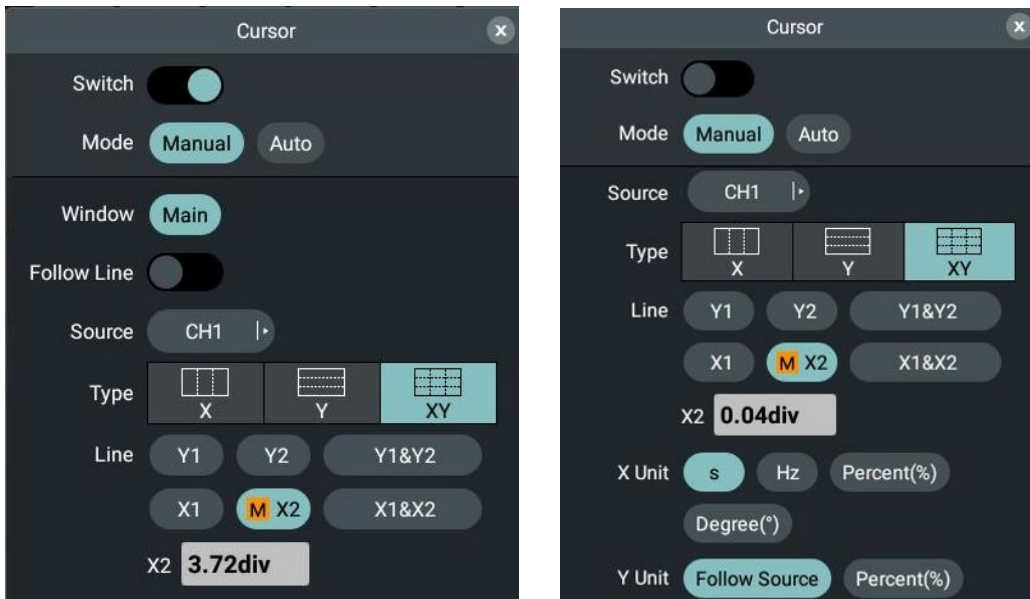

Cursor Measurement in General Mode:

The descriptions of **cursor measurement** setting window are shown in the table below:

Menu	Settings	Descriptions
Switch		Open or close the cursor measurement.
Mode	Manual Auto	Select Cursor Mode. When Auto Mode is selected, the position of the horizontal cursor is automatically set to the intersection of the vertical cursor and the waveform.
Window	Main Other	Measure the main waveform area; Measure other waveform areas (Note: Only available in XY, Zoom, FFT mode.).
Follow Line		Enable or disable the cursor measured value moving with the cursor line.

5. Use the Oscilloscope

Source	Selected Waveform CH1 CH2 CH3 CH4 Math	Select the waveform channel to be measured by the cursor.
Type	X Y XY	Display time measurement cursor and menu. Display voltage measurement cursor and menu. Display time and voltage measurement cursor and menu.
Line	X1 X2 X1&X2 Y1 Y2 Y1&Y2 Input Box	Select X1 vertical cursor line. Select X2 vertical cursor line. Select X1 and X2 vertical cursor lines simultaneously. Select a cursor line and turn General knob or drag the cursor line with the finger to move the cursor line. Select Y1 horizontal cursor line. Select Y2 horizontal cursor line. Select Y1 and Y2 horizontal lines simultaneously. Select a cursor line and turn General knob or drag the cursor line with the finger to move the cursor line. Click Input Box to set the cursor position required.
Unit	X Unit Y Unit	s Hz Percent(%) Degree(°) Follow Source Percent(%)
		Select the display unit of cursor measurement. The display unit of Y cursor display value is subject to the unit of signal source (V.A.W.U) or the percentage.

To conduct cursor measurements of CH1 time and voltage, perform the following operating steps:

1. Press **Cursor** key to pop up cursor measurement setting window. The cursor information display bar located to the right of the waveform display area displays the cursor readings.
2. In the setting window, select **Window** as **Main** .
3. In the setting window, select **Source** as **CH1**.

4. Set Cursor Type

- Click **X** in the type menu to highlight it, and two yellow dotted lines X1 and X2 are displayed in the vertical direction of the screen;
- Click **Y** in the type menu to highlight it, and two yellow dotted lines Y1 and Y2 are displayed in the horizontal direction of the screen;
- Click **XY** in the type menu, two yellow dotted lines X1 and X2 in the vertical direction and two yellow dotted lines Y1 and Y2 in the horizontal direction are displayed in the screen.

5. Set Cursor Line

- Click **Y1** or **Y2** in the Cursor Line menu, turn **General** knob to move the cursor lines **Y1** or **Y2** up and down; select **Y1&Y2** and turn **General** knob to move the cursor lines Y1 and Y2 up and down simultaneously;
- Click **X1** or **X2** in the Cursor Line menu, turn **General** knob to move the cursor lines **X1** or **X2** left and right; select **X1&X2** and turn **General** knob to move the cursor lines X1 and X2 left and right simultaneously.

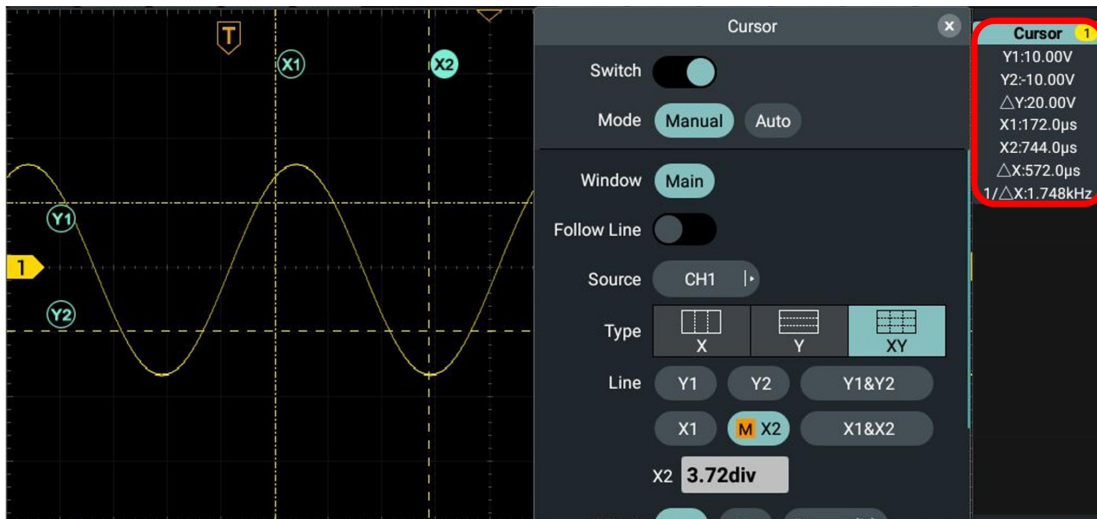

Figure 5-8:Time &Voltage Cursor Measurement

Use Gestures To Move The Cursor Line

For operating touch screen in cursor measurement, see “Other touch screen operations” in Page 28.

Cursor Measurement in Zoom Mode

To perform a Zoom cursor measurement, perform the following steps:

1. Click **Zoom** shortcut at the top of screen, press **Horizontal Scale** knob or click the **Horizontal Information Display Bar** to enter the zoom mode.
2. Press **Cursor** key to pop up the cursor measurement setting window.
The cursor information display bar located to the right of the waveform display area displays the cursor readings.
3. In setting window, select **Window** as **Zoom**, can make the cursor line appear in the main waveform area or Zoom waveform area.
4. Set Cursor Type
 - Click **X** in the type menu to highlight it, and two dotted lines X1 and X2 are displayed in the horizontal direction of the screen;
 - Click **Y** in the type menu to highlight it, and two dotted lines Y1 and Y2 are displayed in the horizontal direction of the screen;
 - Click **XY** in the type menu and two dotted lines X1 and X2 in the vertical direction and two dotted lines Y1 and Y2 in the horizontal direction are displayed on the screen.
5. Set Cursor Line
 - Click **Y1** or **Y2** in the cursor line menu and turn **General** knob to move the cursor lines **Y1** or **Y2** up and down; select **Y1&Y2** and turn **General** knob to move two cursor lines **Y1** and **Y2** up and down simultaneously;
 - Click **X1** or **X2** in the cursor line menu and turn **General** knob to move the cursor lines **X1** or **X2** left and right; select **X1&X2** and turn **General** knob to move two cursor lines **X1** and **X2** left and right simultaneously.

Cursor Measurement in FFT Mode

To perform a FFT cursor measurement, perform the following steps:

1. Click **FFT** shortcut at the top of screen, then FFT information display bar will display in the bottom of screen, click the information display bar will pop up FFT setting window. You can select **Vrms** , **dBVrms** , **Radians** , **Degrees** in **Vertical Units** .
2. Press **Cursor** key to pop up the cursor measurement setting window.

The cursor information display bar located to the right of the waveform display area displays the cursor readings.

3. In setting window, select **Window** as **FFT**, can make the cursor line appear in the main waveform area or FFT waveform area.
4. Set Cursor Type
 - Click **X** in the type menu to highlight it, and two pink dotted lines X1 and X2 are displayed in the horizontal direction of the screen;
 - Click **Y** in the type menu to highlight it, and two pink dotted lines Y1 and Y2 are displayed in the horizontal direction of the screen;
 - Click **XY** in the type menu and two pink dotted lines X1 and X2 in the vertical direction and two pink dotted lines Y1 and Y2 in the horizontal direction are displayed on the screen.
5. Set Cursor Line
 - Click **Y1** or **Y2** in the cursor line menu and turn **General** knob to move the cursor lines **Y1** or **Y2** up and down; select **Y1&Y2** and turn General knob to move two cursor lines **Y1** and **Y2** up and down simultaneously;
 - Click **X1** or **X2** in the cursor line menu and turn **General** knob to move the cursor lines **X1** or **X2** left and right; select **X1&X2** and turn **General** knob to move two cursor lines **X1** and **X2** left and right simultaneously.

Cursor Measurement in XY Mode

To perform a XY cursor measurement, perform the following steps:

1. Click **XY Mode** shortcut at the top of screen can directly enable XY mode.
2. Press **Cursor** key to pop up the cursor measurement setting window.

The cursor information display bar located to the right of the waveform display area displays the cursor readings.
3. In setting window, select **Window** as **XY**, can make the cursor line appear in the main waveform area or XY waveform area.
4. The **XY** in the type menu is highlighted and two dotted lines X1 and X2 in the vertical direction and two dotted lines Y1 and Y2 in the horizontal

direction are displayed on the screen.

5. Set Cursor Line

- Click **Y1** or **Y2** in the cursor line menu and turn **General** knob to move the cursor lines **Y1** or **Y2** up and down; select **Y1&Y2** and turn General knob to move two cursor lines **Y1** and **Y2** up and down simultaneously;
- Click **X1** or **X2** in the cursor line menu and turn **General** knob to move the cursor lines **X1** or **X2** left and right; select **X1&X2** and turn **General** knob to move two cursor lines **X1** and **X2** left and right simultaneously.

How to Realize Waveform Operation Function

Waveform operation functions include addition, subtraction, multiplication, division, integration, differentiation, square root and custom function operations for Channel 1, Channel 2, Channel 3 and Channel 4 waveforms.

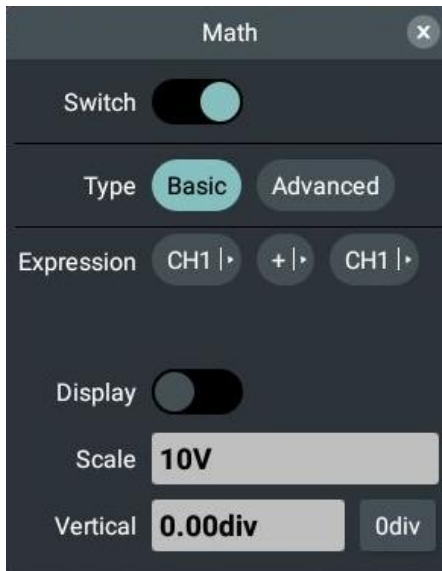

Click  in the right corner of the screen, then select **Math** to display setting window, as shown in the figure below.



The descriptions of **Math** setting window are shown in the table below:

Menu	Settings	Descriptions
Switch		Open or close the waveform mathematics.
Type	Basic	Waveform calculation of simple addition, subtraction, multiplication and division for CH1, CH2, CH3 and CH4.1` Advanced waveform calculation for CH1, CH2,



5. Use the Oscilloscope

	Advanced	CH3 and CH4, such as integration, calculus, square roots or custom function operations.
Expression	CH1 ▶	Select CH1, CH2, CH3 or CH4 signal source.
	+ ▶	Select operation sign.
	CH1 ▶	Select CH1, CH2, CH3 or CH4 signal source.
Display		Open or close math operation formula.
Scale		Turn General knob to adjust the vertical gear of Math waveform.
Vertical		Click Numeric Input Box to directly input the vertical position of the Math waveform to be set and click the unit to confirm; or click Gear Input Box (- or +) or turn General knob to set the vertical position of Math waveform to be set, click < > or press   to move the cursor and select the digit to be set.
	0div	Click 0div , the waveform vertical position can be zero.

Waveform Calculation

Take Channel 1 + Channel 2 as an example, the operating steps are as follows:



1. Click  in the right corner of screen, then select **Math**, the screen will pop up math setting window.
2. Click **Switch** to highlight it, and the pink waveform M will display on the screen.
3. Click **Basic** to highlight it.
4. Click **CH1| ▶** to select **CH1**.
5. Click **+| ▶** to select **+**.
6. Click **CH1| ▶** to select **CH2**.
7. Click **Display**. When the switch label is highlighted on the right, it is enabled. The pink Math and formula will be displayed at the lower left corner of the screen.
8. Click the Numeric Display Box of **Scale** and turn **General** knob to adjust the vertical scale of Math waveform.

- Click **Vertical**, click Numeric Input Box to directly input the vertical position of **Math** waveform to be set and click the unit to confirm; or click Gear Input Box (- or +) or turn **General** knob to set the vertical position of **Math** waveform to be set and click < > or press   to move the cursor and select the digit to be set.

Custom Function Operation

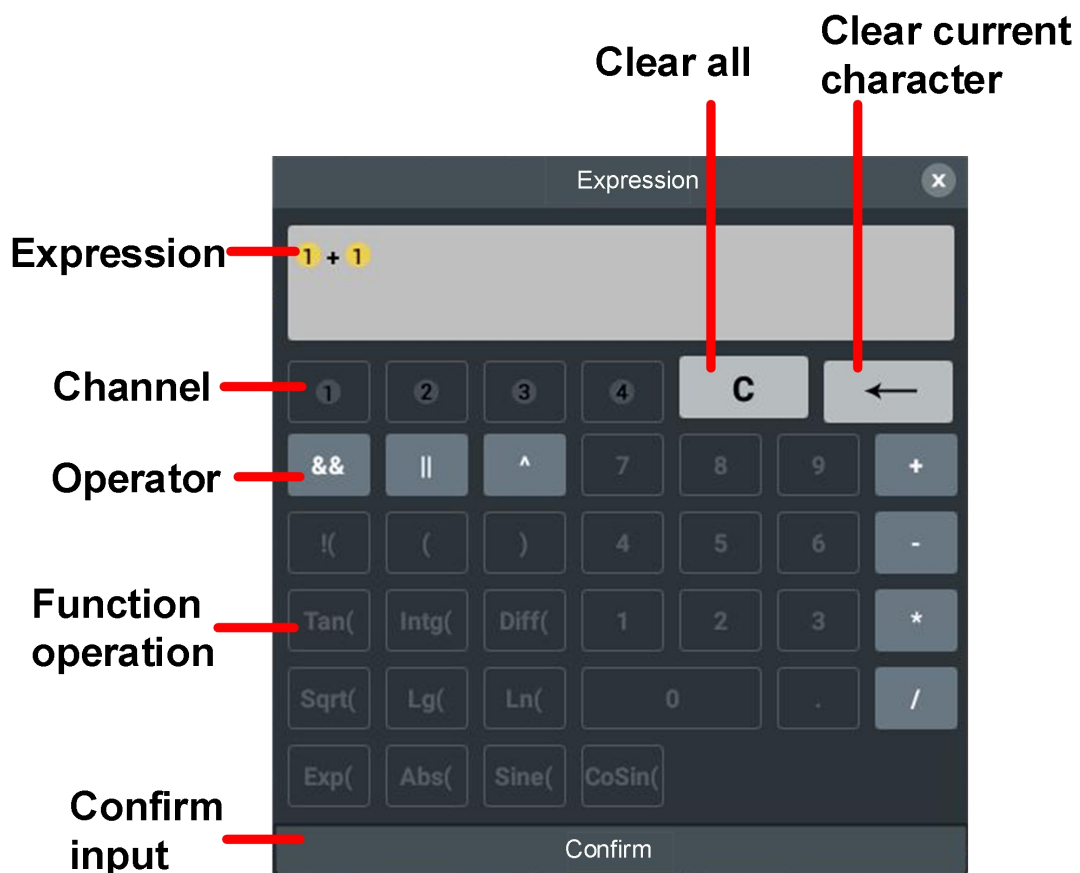
- Click  in the right corner of screen, then select **Math**, the screen will pop up math setting window.
- Click **Switch** to highlight it, and the pink waveform M will display on the screen.
- Click **Advanced** to highlight it.
- Click **Expression** Display Box to pop up expression input soft keyboard on the screen.



5. Create the expression, then select **Confirm** in the keyboard to implement.
6. Click **Display**. When the switch label is highlighted on the right, it is enabled. The formula will be displayed at the lower left corner of the screen.
7. Click the Numeric Display Box of **Scale** and turn **General** knob to adjust the vertical scale of Math waveform.
8. Click **Vertical**, click Numeric Input Box to directly input the vertical position of **Math** waveform to be set and click the unit to confirm; or click Gear Input Box (- or +) or turn **General** knob to set the vertical position of **Math** waveform to be set and click < > or press   to move the cursor and select the digit to be set.

How To Set FFT

FFT decomposes the signal into component frequencies, and the oscilloscope uses these component frequencies to display the graph of signal frequency domain, which corresponds to the standard time domain graph of the oscilloscope. Then match these frequencies with known system frequencies, such as the system clock, oscilloscope or power supply.

The FFT operation of this instrument can convert data points of the time domain waveform into frequency domain signal. The maximum number of analysis points for FFT calculation is 1 Mpts.

The FFT setting window is shown as follows:

5. Use the Oscilloscope

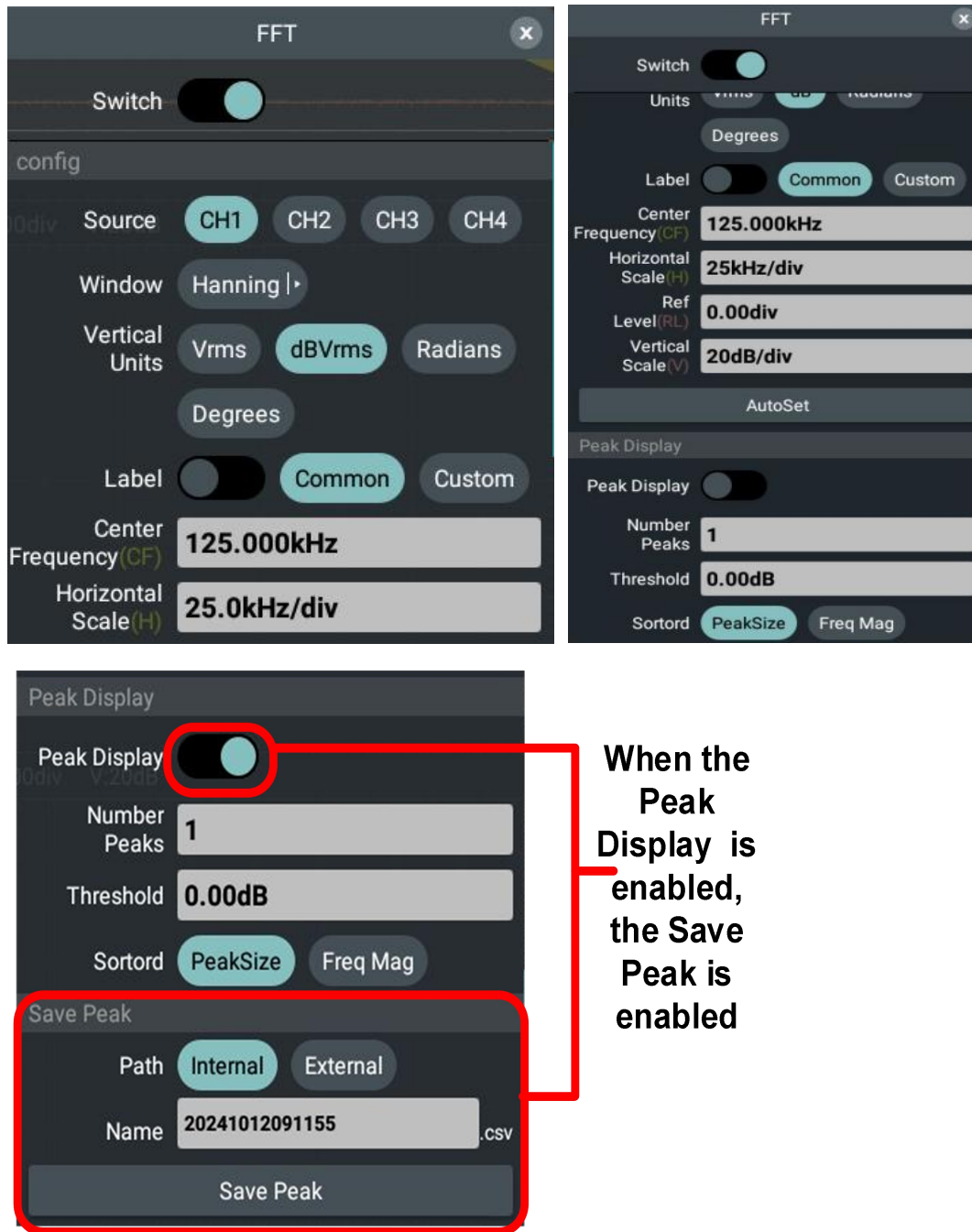

FFT operating steps are as follows:

1. Click  in the right corner of screen, then select **FFT**, the screen will pop up FFT setting window.
2. Click **Switch** when the switch label is highlighted on the right, it is enabled. The pink waveform M will be displayed on the screen (It is also available to click FFT shortcut softkey at the upper part of the screen).
3. Click the signal source **CH1**.

4. Click **Rectangle** and select the window type to be used from the displayed window.
5. Click **Vertical Units** and select **Vrms**, **dBVrms**, **Radians** or **Degrees**.
6. Click **Label**, when the switch label is highlighted on the right, it is enabled. You can choose common or custom label type.
7. Click **Center Frequency**, **Horizontal Scale**, **Ref Level**, **Vertical Scale** Numeric Display Box respectively and set the value required. Or click **AutoSet** in the FFT display can observe suitable waveforms.
8. Click **Peak Display**, when the switch label is highlighted on the right, it is enabled. A peak display list appears at the top left of the screen. The number of lists is determined by the number of peaks and the threshold. The peak display list is displayed at the top left of the waveform.
9. Click **Number Peaks** Numeric Display Box, set the value required and setting range is 1 to 15.
10. Click **Threshold** Numeric Display Box and set the value required. The threshold range is related to the current FFT gear and offset.
11. Click **Sortord** and select the sortord type **PeakSize** or **Freq Mag**.
12. Click **Path** and select the save path is **Internal** or **External**.
13. Click **Name** Numeric Display Box and set the name required.
14. Click **Save Peak** to save the file.





Note: 12-14 valid only when peak display is on.

The Description of FFT Window

There are 6 FFT windows. Each one has trade-offs between frequency resolution and amplitude accuracy. What you want to measure and your source signal characteristics help you to determine which window to use. Use the following guidelines to select the best window.

Type	Descriptions	Window
Rectangle	Best solution for frequency, worst for amplitude. Best type for measuring the frequency spectrum of nonrepetitive signals and	

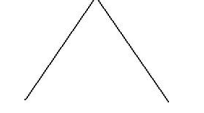
5. Use the Oscilloscope

	<p>measuring frequency components near DC. Recommend to use for:</p> <ul style="list-style-type: none"> • Transients or bursts, the signal level before and after the event are nearly equal. • Equal-amplitude sine waves with frequencies those are very close. <p>Broadband random noise with a relatively slow varying spectrum.</p>	
Hanning	<p>Good for amplitude, but poorer frequency resolution than Hamming. Recommend to use for:</p> <ul style="list-style-type: none"> • Sine, periodic and narrow band random noise. • Transients or bursts where the signal levels before and after the event are significantly different. 	
Hamming	<p>Better solution for amplitude than Rectangle, and good for frequency as well. It has slightly better frequency resolution than Hanning. Recommend to use for:</p> <ul style="list-style-type: none"> • Sine, periodic and narrow band random noise. • Transients or bursts where the signal levels before and after the event are significantly different. 	
Blackman	<p>Best solution for amplitude, worst for frequency. Recommend to use for:</p> <ul style="list-style-type: none"> • Single frequency waveforms, to find higher order harmonics. 	
Bartlett	<p>The Bartlett window is a slightly narrower variant of the triangular window, with zero weight at both ends.</p>	
Kaiser	<p>The frequency resolution when using the Kaiser window is fair; the spectral leakage and amplitude accuracy are both good. The Kaiser window is best used when frequencies are very close to the same value but have widely differing amplitudes (the side lobe level and shape factor are closest to the traditional Gaussian RBW). This window is also good for random signals.</p>	

Notes for using FFT

- Use the default **dBVrms** scale for details of multiple frequencies, even if they have very different amplitudes. Use the **dBVrms** scale to compare frequencies.
- DC component or offset can cause incorrect magnitude values of FFT waveform. To minimize the DC component, choose AC Coupling on the source signal.
- To reduce random noise and aliased components in repetitive or single-shot events, set the oscilloscope acquisition mode to average.

What is Nyquist frequency:

The Nyquist frequency is the highest frequency that any real-time digitizing oscilloscope can acquire without aliasing. This frequency is half of the sample rate. Frequencies above the Nyquist frequency will be under sampled, which causes aliasing. So pay more attention to the relation between the frequency being sampled and measured.



How To Set DIR(Digital Filtering)

Digital filtering supports low pass, high pass, band pass and band reject types, and the specific frequency in the signal can be filtered out by setting the cut-off frequency. The setting window is shown as below.



1. Click **DIR** in the analysis module from the main menu window  at the

lower right of the screen.

2. In the setting window, click **Switch** when the switch label is highlighted on the right, it is enabled. The pink waveform M will be displayed on the screen.
3. Select CH1, CH2, CH3 or CH4 in the **Source** option.
4. Select the filter required in the **Type** option.
5. Select the appropriate window in the **Window** option.
6. Click **Cut Off** frequency numeric window:
 When **Low Pass** or **High Pass** is selected as the filter type, it is available to set the required cut-off frequency in the lower part of the menu.
 When **Band Pass** or **Band Reject** is selected as the filter type, it is available to set the required **Up** frequency limit or **Down** frequency limit in the lower part of the menu.
7. Click **Vertical** in the option, directly click Numeric Input Box to input the vertical position of the Math Waveform to be set and click the unit or OK to confirm; or click Gear Input Box (- or +) or turn **General** knob to set the vertical position of the Math Waveform to be set, click < > or press   to move the cursor and select the digit to be set. The voltage gear of the Math Waveform is the same as that of the current channel.

Note: In slow sweep, the digital filter function is disabled.

How To Set Pass Fail

Click **Pass Fail** in the analysis module from the main menu window  at the lower right of the screen. The descriptions of the setting window are shown in the table below:

Menu	Settings	Descriptions	
Switch		Open or close Pass/Fail measure function.	
Operate		Control operate switch.	
Configuration	Source	CH1 CH2 CH3	Select CH1, CH2, CH3 or CH4 source.

5. Use the Oscilloscope

		CH4	
	Category	PASS FAIL	Select pass or fail set type. Pass: The measured signal conforms to the set rules. Fail: The measured signal doesn't conform to the set rules.
	Stop		Open or close Stop function. When enabled, it stops as soon as the set rules are met.
	Beep		Open or close Beep function. When enabled, the beep rings when the setting is met.
	Message Display		Open or close pass/fail message display navigate window.
TheMaskRule	Horizontally Disposed		0.01~2div, click Numeric Input Box, set the horizontal value required.
	Vertically Disposed		0.04~2div, click Numeric Input Box, set the vertical value required.
	CreateRule		Click to set the conditions as the test rules.
Mask save & read	0 Null ... 7 Null		According to require test rule, can set 8 groups test rules. Note: Null: Indicates empty, no rule is created; Rule: Indicates that a rule has been created.
	Save		Click and save the set test rules.
	Rename		According to requirement to rename the rule.
	Read		Click to print the saved test rule.

Pass/Fail: It detects whether the input signal of the channel is within the rules. If it is out of range, it is a failure; otherwise, it is a pass. It can output failure or pass signal through the built-in, configurable output port.

To perform a Pass/Fail test, follow these steps:

1. Click **Pass Fail** in the analysis module in the main setting window at the bottom right of the screen .
2. In the setting window, click **Switch** when the switch label is highlighted on the right, it is enabled.
3. **Configuration:** In the configuration menu, set output type is **PASS** or **FAIL**; set output mode whether to open **Stop** or **Beep**; set whether to open **Message Display**.

4. **TheMaskRule:** In TheMaskRule menu select **Source**, in **Horizontally Disposed** or **Vertically Disposed**, click Numeric Input Box, set horizontal value or vertical value; click to **CreateRule**.
5. **Operate:** Click **Operate**, when the switch label is highlighted on the right, it is enabled.
6. **Mask save & Read:** Select **Save** in the bottom of the screen, you can call the **Read** immediately when you need it later.

Note:

1. In the case of Pass/Fail on, open XY, FFT or Zoom mode, Pass/Fail will close; In XY, FFT or Zoom mode, Pass/Fail function menu is gray, it can not to use.
2. In the case of factory setting on, Pass/Fail will close.
3. During the detection process, the signal source cannot be modified, and the output stop, ring, create rule, save, and read operations cannot be performed. Only the information display and switch operations can be performed.
4. In stop state, don't compare data. While continuing to run, pass fail total will add it, doesn't start at 0.

How To Set Counter

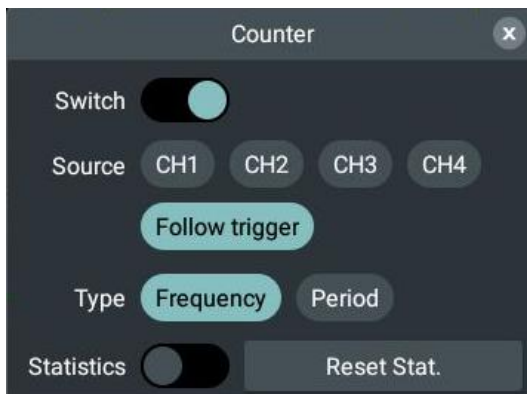

To perform counter, follow these steps:

1. Click **Counter** in the analysis module in the main setting window at the

bottom right of the screen . The setting window will display on the screen.

2. In the setting window, click **Switch** when the switch label is highlighted on the right, it is enabled, counter menu will display in the right list. And click **Switch** again or draw the information bar to the right, can close the function.
3. Select CH1, CH2, CH3, CH4 or Follow trigger in the **Source** option.
4. Select Frequency or Period in the **Type** option.
5. Click **Statistics** when the switch label is highlighted on the right, it is enabled, counter will display Type, Max, Min and Avg; If off, only the Type is displayed.

Note: Click  on the top right corner of the counter information display bar can directly enable or disable the statistics function.

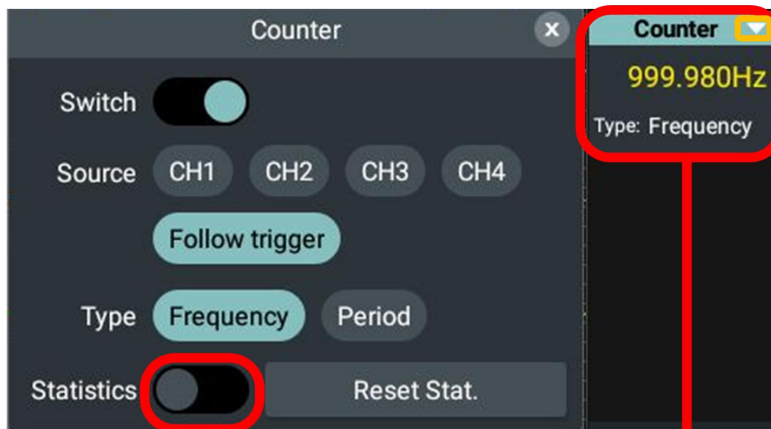

Click to open the statistics function directly

The statistics function is not turned on, and the Counter only displays the measurement type

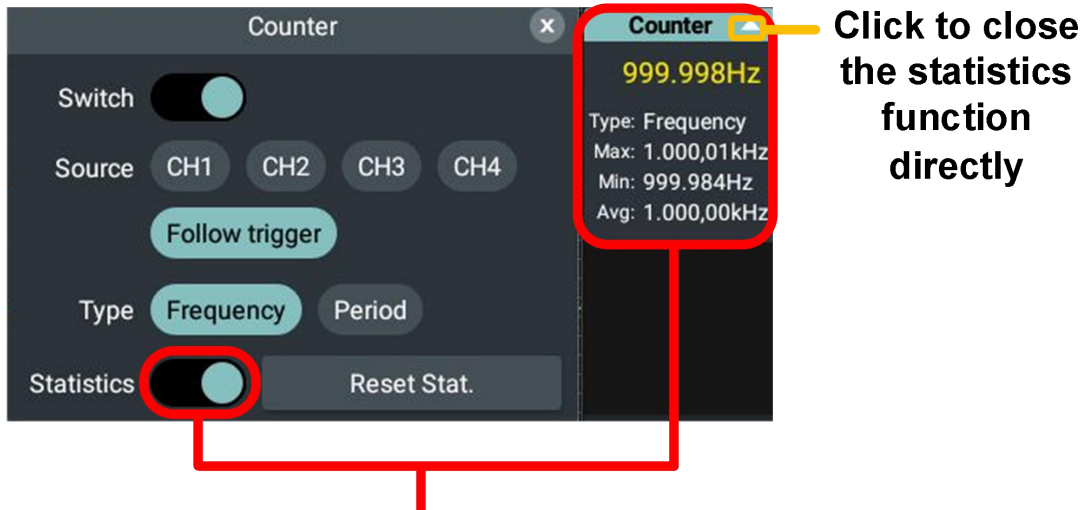

The statistical function is turned on, and the Counter displays the measurement type, maximum value, minimum value and average value

- Click **Reset Stat.**, the historical data of the counter will be cleared and the statistics will be re-conducted.

How To Set DVM

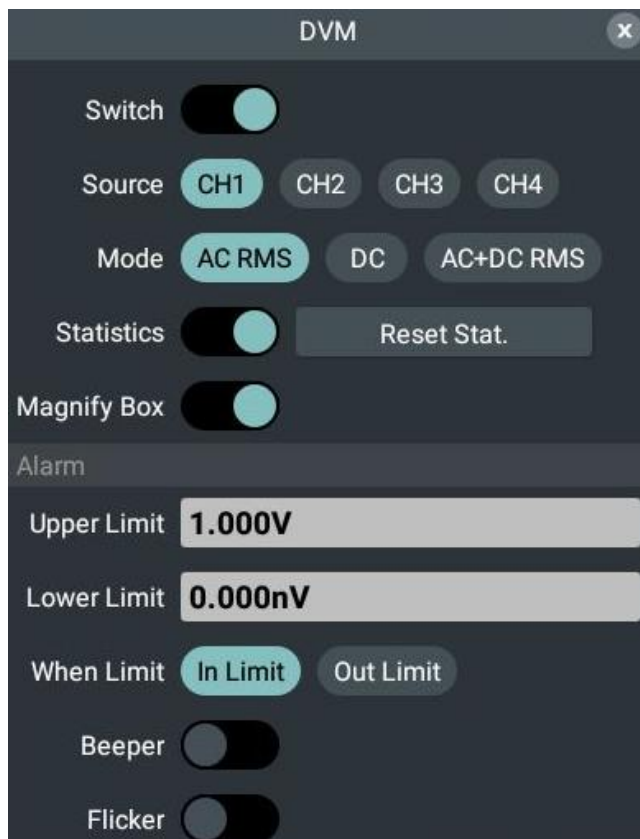

To perform DVM, follow these steps:

1. Click **DVM** in the analysis module in the main setting window at the bottom right of the screen . The setting window will display on the screen.
2. In the setting window, click **Switch** when the switch label is highlighted on the right, it is enabled, DVM information display bar will display in the right list. And click **Switch** again or draw the information bar to the right, can close the function.
3. Select CH1, CH2, CH3 or CH4 in the **Source** option.
4. Select AC RMS, DC or AC+DC RMS in the **Mode** option.
5. Click **Statistics** when the switch label is highlighted on the right, it is enabled, DVM will display Type, Max, Min and Avg; if off, only the Type is displayed.

Note: Click  on the top right corner of the DVM information display bar can directly enable or disable the statistics function.

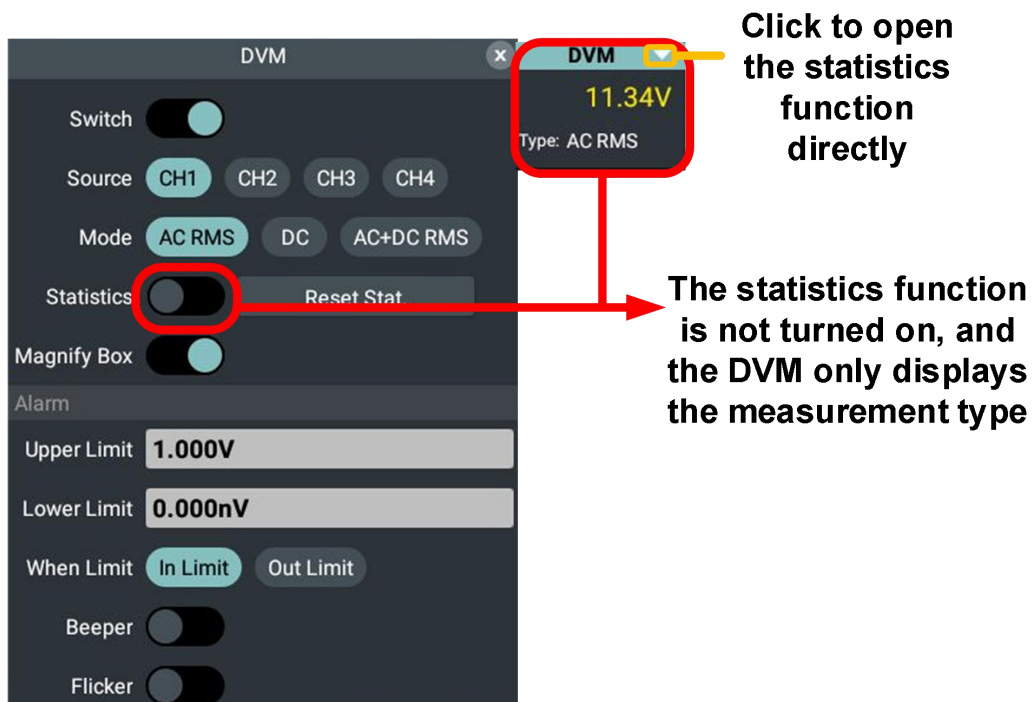

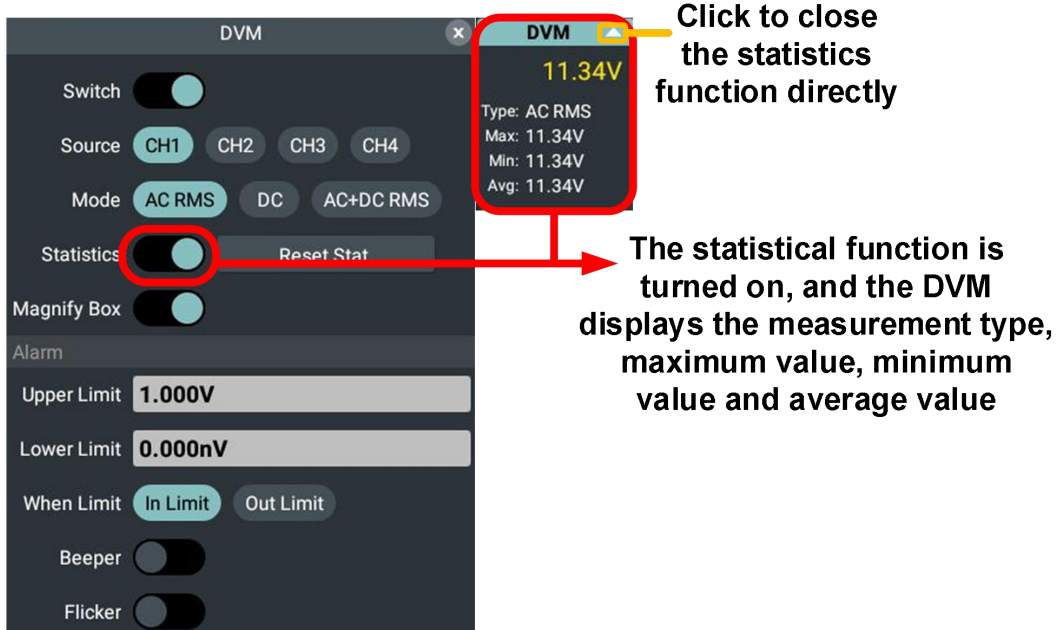

6. Click **Reset Stat.**, the historical data of the DVM will be cleared and the statistics will be re-conducted.
7. Click **Magnifier Box** when the switch label is highlighted on the right, it is enabled. The zoom box will appear at the top right of the screen, and the number will match the number in the list on the right.

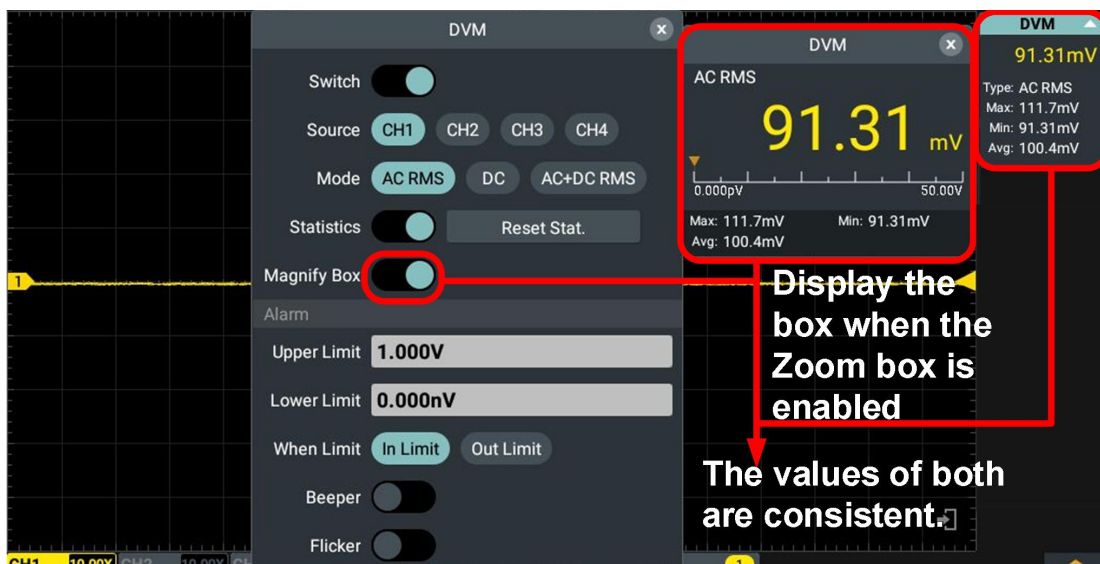

8. **Alarm:** In the **Upper Limit** or **Lower Limit** option, click Numeric Input Box to set the upper or lower limit vale. In **When Limit** to set the limit condition to **In Limit** or **Out Limit**. Set the switch whether to turn on the alarm sound.

9. **Flicker:** In the **Upper Limit** or **Lower Limit** option, click Numeric Input Box to set the upper or lower limit value. In **When Limit** to set the limit condition to **In Limit** or **Out Limit**. Set the switch whether to turn on the Flicker. The DVM information display panel on the right-side list will enter a blinking state if the measured values meet the predefined conditions.

How To Set Decode

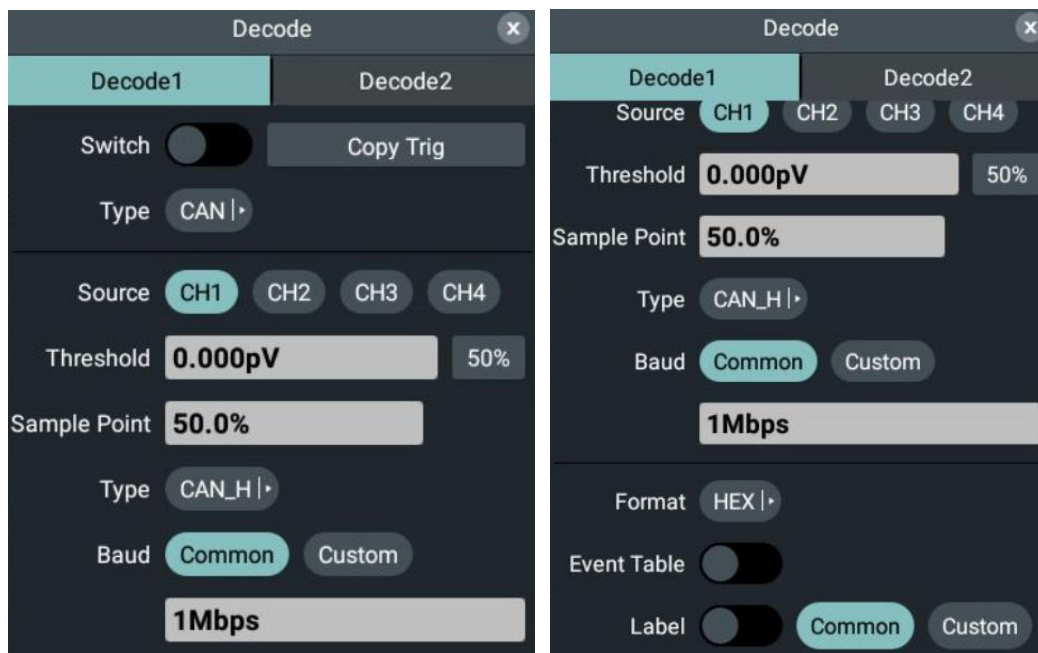

To perform Decode, follow these steps:

1. Click **Decode** in the analysis module in the main setting window at the bottom right of the screen .
2. The setting window will display on the screen. Click **Decode1** or **Decode2** to set decode. Click **Switch**, when the switch label is highlighted on the right, it is enabled.
3. Select RS232/UART, I2C, SPI, CAN or LIN in **Type** option. Click **Copy Trig**, the settings for the trigger type can be copied.
4. Select HEX, DECIMAL, BINARY or ASCII, in **Format** option.
5. Click **Event Table**, when the switch label is highlighted on the right, it is enabled. A list of decoders is displayed on the left side of the screen.

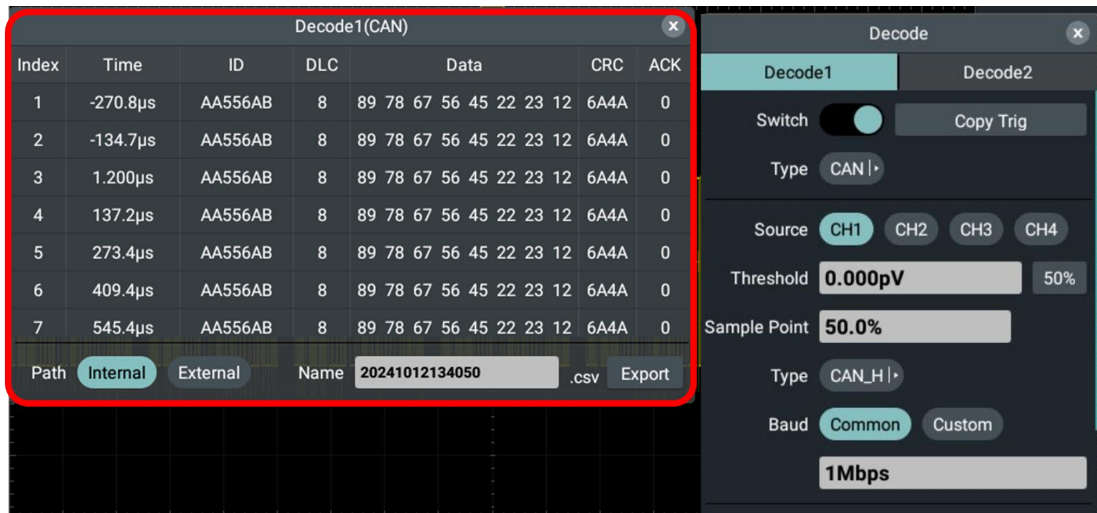

- In the **Path** option, select the storage path as Internal or External; click **Name** Input Box can edit the filename or save the waveform with the system default filename, the file format is csv; click **Export**, can save the file.
6. Click **Label**, when the switch label is highlighted on the right, it is enabled. You can select Common or Custom as the label type.

RS232/UART Decode





To perform decode RS232/UART signal, follow these steps:

- (1) Connect the RS232/UART signal to the Signal Input Channel of the oscilloscope.
- (2) Adjust to the proper time base and voltage division.
- (3) In trigger menu, select trigger type as RS232/UART, set parameters based on the characteristics of the signal, trigger the signal correctly and obtain stable display. Refer to “RS232/UART Trigger” on P60.
- (4) After the signal is stabilized and triggered, click **Decode** in the analysis module in the main setting window at the bottom right of the screen . Select the type as RS232/UART, set parameters based on the characteristics of the signal. When the parameters are set correctly, the information carried by the signal will be displayed.

Note:

- When decoding, if "Parity" is not set to "None", and the check bit error is detected, **P** marks will be displayed in the corresponding position in the waveform.

The descriptions of **RS232/UART** decode setting window are as shown in the table below:

Menu	Settings	Descriptions
Switch	Copy Trig	Click Switch , when the switch label is highlighted on the right, it is enabled. Click the Copy Trig button to copy the current trigger settings to the decoding function.
Type	RS232/UART	Set the decode type as RS232/UART.
Source	CH1 CH2 CH3 CH4	Select CH1, CH2, CH3 or CH4 as the decode signal source.
Threshold	50%	Click Numeric Display Box and turn General knob to set the lower threshold; Click 50% and set the shortcut key of trigger level in the vertical midpoint of the trigger signal amplitude.
Polarity		Select positive polarity for data transmission.
		Select reverse polarity for data transmission.
Baud	Common	Click Numeric Display Box and turn General knob to set the commonly-used baud rate.
	Custom	Click Numeric Display Box to input the baud rate to be set and click unit to confirm; or click Gear Input Box (- or +) or turn the General knob to set the baud rate, and click < > or press  or  to move the cursor and select the digit to be set. The baud rate ranges from 50 to 10,000,000. Note: You can select the nearest value in Common Baud, and then adjust it in this menu.
Data Bits	5, 6, 7, 8	Set the data width of each frame to match the signal. It can be set to 5, 6, 7 or 8.
Parity	None, Odd, Even	Set the even-odd check mode to match the polarity used by the signal.
Stop Bit	1, 1.5, 2	Select 1, 1.5 or 2 as the end of decoding sign.

5. Use the Oscilloscope

Endian	LSB	LSB:Least Significant Bit, that is, the data is transmitted low first.
	MSB	MSB:Most Significant Bit, that is, the data is transmitted high first.
Format	HEX DECIMAL BINARY ASCII	Select the display format to decode.
Event Table		Click Switch , when the switch label is highlighted on the right, it is enabled. The decode list will display on the screen.
Label	Common Custom	Click Label , when the switch label is highlighted on the right, it is enabled. You can select Common or Custom as the label type.

I2C Decode

To perform decode I2C signal, follow these steps:

- (1) Connect the clock line (SCLK) and the data line (SDA) of the I2C signal to the Signal Input Channels of the oscilloscope.
- (2) Adjust to the proper time base and voltage division.
- (3) In trigger menu, select trigger type as I2C, set parameters based on the characteristics of the signal, trigger the signal correctly and obtain stable display. Refer to “I2C Trigger” on P62.
- (4) After the signal is stabilized and triggered, click **Decode** in the analysis module in the main setting window at the bottom right of the screen . Select the type as I2C, set parameters based on the characteristics of the signal. When the parameters are set correctly, the information carried by the signal will be displayed.

Decoded information interpretation:

Information	Abbreviation
Read Address	R
Write Address	W

The descriptions of **I2C** decode setting window are as shown in the table below:

5. Use the Oscilloscope

Menu	Settings	Descriptions
Switch	Copy Trig	Click Switch , when the switch label is highlighted on the right, it is enabled. Click the Copy Trig button to copy the current trigger settings to the decoding function.
Type	I2C	Set the decode type as I2C.
SCL	CH1 CH2 CH3 CH4	Select CH1,CH2,CH3 or CH4 as SCL.
Threshold	50%	Click Numeric Display Box and turn General knob to set the lower threshold; Click 50% and set the shortcut key of trigger level in the vertical midpoint of the trigger signal amplitude.
SDA	CH1 CH2 CH3 CH4	Select CH1,CH2,CH3 or CH4 as SDA.
Threshold	50%	Click Numeric Display Box and turn General knob to set the lower threshold; Click 50% and set the shortcut key of trigger level in the vertical midpoint of the trigger signal amplitude.
Source	Exchange	Click Exchange , the sources of SCL and SDA can be exchanged.
R/W	With Without	When read and write bits are not included, they are added automatically depending on the function.
Format	HEX DECIMAL BINARY ASCII	Select the display format to decode.
Event Table		Click Switch , when the switch label is highlighted on the right, it is enabled. The decode list will display on the screen.
Label	Common Custom	Click Label , when the switch label is highlighted on the right, it is enabled. You can select Common or Custom as the label type.

SPI Decode





To perform decode SPI signal, follow these steps:

- (1) Connect the clock line (SCLK) and the data line (SDA) of the SPI signal to the Signal Input Channels of the oscilloscope.
- (2) Adjust to the proper time base and voltage division.
- (3) In trigger menu, select trigger type as SPI, set parameters based on the characteristics of the signal, trigger the signal correctly and obtain stable display. Refer to “SPI Trigger” P64.
- (4) After the signal is stabilized and triggered, click **Decode** in the analysis module in the main setting window at the bottom right of the screen . Select the type as SPI, set parameters based on the characteristics of the signal. When the parameters are set correctly, the information carried by the signal will be displayed.

The descriptions of **SPI** decode setting window are as shown in the table below:

Menu	Settings	Descriptions
Switch	Copy Trig	Click Switch , when the switch label is highlighted on the right, it is enabled. Click the Copy Trig button to copy the current trigger settings to the decoding function.
Type	SPI	Set the decode type as SPI.
Mode	CLK	Select CH1,CH2,CH3 or CH4 as CLK.
	50%	Click Numeric Display Box and turn General knob to set the lower threshold; Click 50% and set the shortcut key of trigger level in the vertical midpoint of the trigger signal amplitude.
	MISO /MOSI	Select CH1,CH2,CH3 or CH4 as MISO/MOSI.
	50%	Click Numeric Display Box and turn General knob to set the lower threshold; Click 50% and set the shortcut key of trigger level in the vertical midpoint of the trigger signal amplitude.
	Timeout	Click Numeric Display Box and turn General knob to set the required timeout.
C	CLK	Select CH1,CH2,CH3 or CH4 as CLK.

5. Use the Oscilloscope

S	50%	Click Numeric Display Box and turn General knob to set the lower threshold; Click 50% and set the shortcut key of trigger level in the vertical midpoint of the trigger signal amplitude.
	MISO	Select CH1,CH2,CH3 or CH4 as MISO.
	50%	Click Numeric Display Box and turn General knob to set the lower threshold; Click 50% and set the shortcut key of trigger level in the vertical midpoint of the trigger signal amplitude.
	MOSI	Select CH1,CH2,CH3 or CH4 as MOSI;or select OFF to close MOSI.
	50%	Click Numeric Display Box and turn General knob to set the lower threshold; Click 50% and set the shortcut key of trigger level in the vertical midpoint of the trigger signal amplitude.
	CS	Select CH1, CH2, CH3, CH4 as CS; or select High effective or Low effective as CS.
	50%	Click Numeric Display Box and turn General knob to set the lower threshold; Click 50% and set the shortcut key of trigger level in the vertical midpoint of the trigger signal amplitude.
Polarity		Select positive polarity for data transmission.
		Select reverse polarity for data transmission.
ClockEdge		Set the clock edge to rising edge or falling edge. The rising edge refers to acquire the data at the rising edge of the clock; the falling edge refers to acquire the data at the falling edge of the clock.
		
Data Bits		Click Numeric Display Box and turn General knob to set the data bit width.
Endian	LSB	LSB: Least Significant Bit, that is, the data is transmitted low first.
	MSB	MSB: Most Significant Bit, that is, the data is transmitted high first.
Label	Common Custom	Click Label , when the switch label is highlighted on the right, it is enabled.You can select Common or Custom as the label type.

Format	HEX DECIMAL BINARY ASCII	Select the display format to decode.
Event Table		Click Switch , when the switch label is highlighted on the right, it is enabled. The decode list will display on the screen.
Label	Common Custom	Click Label , when the switch label is highlighted on the right, it is enabled. You can select Common or Custom as the label type.

CAN Decode

To perform decode CAN signal, follow these steps:

- (1) Connect the CAN signal to the Signal Input Channel of the oscilloscope.
- (2) Adjust to the proper time base and voltage division.
- (3) In trigger menu, select trigger type as CAN, set parameters based on the characteristics of the signal, trigger the signal correctly and obtain stable display. Refer to "CAN Trigger" P66.
- (4) After the signal is stabilized and triggered, click **Decode** in the analysis module in the main setting window at the bottom right of the screen . Select the type as CAN, set parameters based on the characteristics of the signal. When the parameters are set correctly, the information carried by the signal will be displayed.



Note:

- Error Frame, Remote Frame, and Overload Frame will be identified in the "Data" column in the event table (Data Frame will not be identified).

The descriptions of **CAN** decode setting window are as shown in the table below:

Menu	Settings	Descriptions
Switch	Copy Trig	Click Switch , when the switch label is highlighted on the right, it is enabled. Click the Copy Trig button to copy the current trigger settings to the decoding function.

5. Use the Oscilloscope

Type	CAN	Set the decode type as CAN.
Source	CH1 CH2 CH3 CH4	Select CH1,CH2,CH3 or CH4 as the decode signal source.
Threshold	50%	Click Numeric Display Box and turn General knob to set the lower threshold; Click 50% and set the shortcut key of trigger level in the vertical midpoint of the trigger signal amplitude.
Sample Point		Click Numeric Display Box and turn General knob to set the sample point.
Type		Select CAN_H, CAN_L, RX, TX or DIFF as the frame type.
Baud	Common	Click Numeric Display Box and turn General knob to set the commonly-used baud rate.
	Custom	Click Numeric Display Box to input the baud rate to be set and click unit to confirm; or click Gear Input Box (- or +) or turn the General knob to set the baud rate, and click < > or press  or  to move the cursor and select the digit to be set. The baud rate ranges from 10kbps to 1Mbps. Note: You can select the nearest value in Common Baud, and then adjust it in this menu.
Format	HEX DECIMAL BINARY ASCII	Select the display format to decode.
Event Table		Click Switch , when the switch label is highlighted on the right, it is enabled. The decode list will display on the screen.
Label	Common Custom	Click Label , when the switch label is highlighted on the right, it is enabled. You can select Common or Custom as the label type.

LIN Decode



To perform decode LIN signal, follow these steps:

- (1) Connect the LIN signal to the Signal Input Channel of the oscilloscope.
- (2) Adjust to the proper time base and voltage division.
- (3) In trigger menu, select trigger type as LIN, set parameters based on the

characteristics of the signal, trigger the signal correctly and obtain stable display. Refer to “LIN Trigger” P68.

- (4) After the signal is stabilized and triggered, click **Decode** in the analysis module in the main setting window at the bottom right of the screen . Select the type as LIN, set parameters based on the characteristics of the signal. When the parameters are set correctly, the information carried by the signal will be displayed.

The descriptions of **LIN** decode setting window are as shown in the table below:

Menu	Settings	Descriptions
Switch	Copy Trig	Click Switch , when the switch label is highlighted on the right, it is enabled. Click the Copy Trig button to copy the current trigger settings to the decoding function.
Type	LIN	Set the decode type as LIN.
Source	CH1 CH2 CH3 CH4	Select CH1,CH2,CH3 or CH4 as the decode signal source.
Threshold	50%	Click Numeric Display Box and turn General knob to set the lower threshold; Click 50% and set the shortcut key of trigger level in the vertical midpoint of the trigger signal amplitude.
Baud	Common	Click Numeric Display Box and turn General knob to set the commonly-used baud rate.
	Custom	Click Numeric Display Box to input the baud rate to be set and click unit to confirm; or click Gear Input Box (- or +) or turn the General knob to set the baud rate, and click < > or press  or  to move the cursor and select the digit to be set. The baud rate ranges from 50bps to 20kbps. Note: You can select the nearest value in Common Baud, and then adjust it in this menu.
Parity Bit	With Without	In the checkpoint* tab, click on the With or Without checkpoints in the configuration DATA.
Version	1.X 2.X Both	In the version TAB, click to select the protocol version that matches the LIN bus signal as "1.X", "2.X" or "Both".

5. Use the Oscilloscope

Format	HEX DECIMAL BINARY ASCII	Select the display format to decode.
Event Table		Click Switch , when the switch label is highlighted on the right, it is enabled. The decode list will display on the screen.
Label	Common Custom	Click Label , when the switch label is highlighted on the right, it is enabled. You can select Common or Custom as the label type.

How To Set Waveform Record/Player

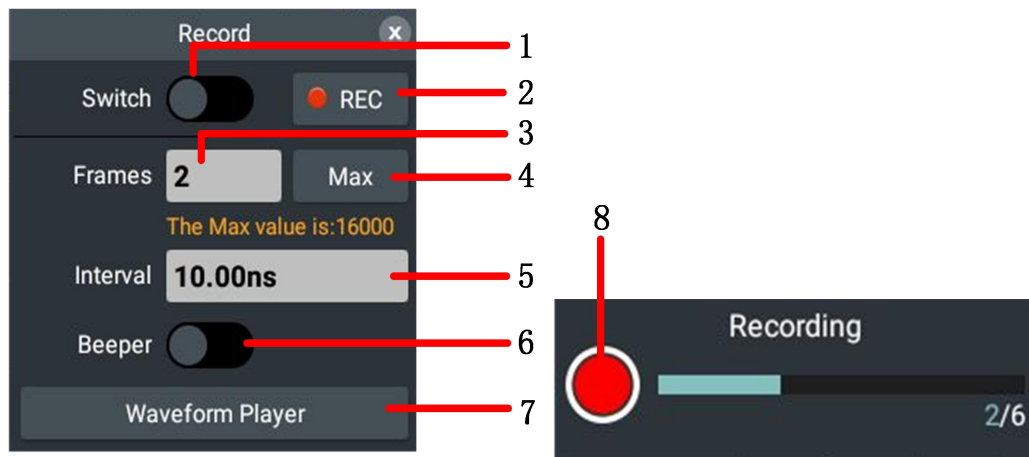

The descriptions of waveform reorder setting window are as shown in the table below:

Number	Description
1	Enable waveform record function.
2	Once all parameters are set, click REC to start recording the waveform.



5. Use the Oscilloscope

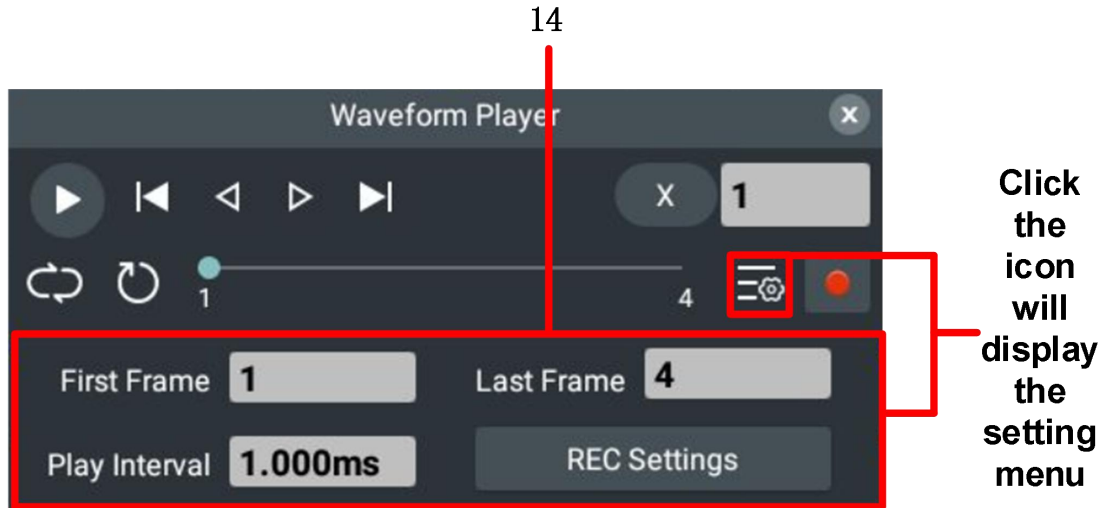

3	<p>The number of recorded frames refers to the actual number of frames that can be recorded. After starting the recording, when the recorded frames reach the set number, the oscilloscope will automatically stop the recording. Click the Numeric Display Box and adjust the General knob or the numeric keypad to set the number of frames. The adjustable range is from 2 to the maximum number of frames that can be recorded. The adjustment range is related to the recording collection length.</p> <table border="1" style="width: 100%; border-collapse: collapse;"> <thead> <tr> <th style="text-align: left;">Record Depth</th> <th style="text-align: left;">Range</th> </tr> </thead> <tbody> <tr> <td>1k</td> <td>2-125000</td> </tr> <tr> <td>10k</td> <td>2-16000</td> </tr> <tr> <td>100k</td> <td>2-2000</td> </tr> <tr> <td>1M</td> <td>2-250</td> </tr> <tr> <td>10M</td> <td>2-16</td> </tr> <tr> <td>25M</td> <td>2</td> </tr> <tr> <td>50M</td> <td>2</td> </tr> </tbody> </table>	Record Depth	Range	1k	2-125000	10k	2-16000	100k	2-2000	1M	2-250	10M	2-16	25M	2	50M	2
Record Depth	Range																
1k	2-125000																
10k	2-16000																
100k	2-2000																
1M	2-250																
10M	2-16																
25M	2																
50M	2																
4	Click Max the number of recorded frames will be automatically set to the maximum number of frames.																
5	Set the time interval between frames during the recording process. The range is from 10ns to 1s.																
6	When the switch is highlighted on the right, it means the function is enabled. At the end of the recording, the buzzer will emit a sound.																
7	Click this button to open the waveform player window.																
8	During waveform recording, clicking will end the recording prematurely.																





The descriptions of waveform player setting window are as shown in the table below:

Number	Description
1	Play button, click it to start or pause the waveform replay.
2	Return to First Frame.
3	Play the previous frame.
4	Play the next frame.
5	Return to Last Frame.
6	Set the current frame. Click the Numeric Display Box and adjust the General knob or the numeric keypad to set the current frame.
7	Restart recording with the current parameters.
8	Click it can display the setting menu.
9	Last frame.
10	Progress bar, drag it to change the current frame.
11	First frame.
12	Click to switch the waveform player direction.  : Sequential playback, from the first frame to the last frame.  : Reverse playback, from the last frame to the first frame.

13	<p>Click to switch the playback mode.</p> <p> : Loop playback: Repeats the playback from the first frame to the last frame until manually stopped.</p> <p> : Single playback: Plays from the current frame to the first/last frame and stops automatically afterward.</p>
14	<p>Set the waveform player information.</p> <p>First Frame: Click the Numeric Display Box and adjust the General knob or the numeric keypad to set the first frame of waveform player. The maximum value can be set to the number of frames that have been recorded.</p> <p>Last Frame: Click the Numeric Display Box and adjust the General knob or the numeric keypad to set the last frame of waveform player. The default value is the number of frames of the recorded waveform.</p> <p>Player Interval: Click the Numeric Display Box and adjust the General knob or the numeric keypad to set the player interval. Range is from 10ns to 1s.</p> <p>REC Settings: Click to reset the waveform recording parameters.</p>

How To Set Others Modulation

Others modulation including: **Display, Save, Reference, Self-Calibration, ProbeCh., Network, About, Config, Hardware-Test.**

How To Set Display System

Click **Display** in the others module in the main setting window at the bottom right of the screen . The descriptions of **Display** setting window are as shown in the table below:

Menu	Settings	Descriptions
Type	Point Vector	Only display the acquisition points. Vector filling displays the space between adjacent acquisition points in the middle.
Persist	Close 1Second 2Seconds 5Seconds Infinity	Select the time of duration. Note:Currently support CH1, CH2, CH3, CH4, FFT, XY, DIR, waveform operation models.

5. Use the Oscilloscope

	Clear	Erase previously collected results from the display. The oscilloscope will start cumulative collection again.
Wave Intensity		Slide adjusts the current wave intensity. Drag the slider to the right of Wave Intensity item to set waveform brightness. The adjustable range is 10% to 100%.
Color Grade		Open or close Color Grade function.
Low refresh rate		Open or close Low refresh rate. You can observe the waveform changing at a low refresh rate .
Show Scale		Open or close Show Scale. When opened, the voltage range is displayed on the right side of the grid, and the time base range is displayed at the bottom.
Grid	FULL GRID HALF NONE	<p>Select the current screen grid type.</p> <ul style="list-style-type: none"> ● FULL: Indicates that the number of display grids on the screen is full. Open background grid, indicates that the number of display grids on the screen is full. Open background grid. ● GRID: Point grid, representing the display grid on the screen in addition to the grid where the scale line is located, every two adjacent scale lines between two small horizontal lines formed a line of points and lines. ● HALF: Semi-grid, indicating that the display grid on the screen closes part of the background grid, leaving only the main grid. ● NONE: No grid indicates that all background grids are closed on the screen.
Grid Brightness		Slide adjusts the current grid brightness. Drag the slider to the right of Grid Brightness item to set grid brightness. The adjustable range is 0% to 100%.
Window Transparency		Slide adjusts the current window brightness. Drag the slider to the right of Window Transparency item to set window brightness. The adjustable range is 0% to 100%.

Afterglow:

When afterglow function is used, the afterglow display of image tube can

be simulated. The color of the original data retained is gradually lightened and that of new data becomes brighter.

- (1) Click **Display** in the others module in the main setting window at the bottom right of the screen .
- (2) Click **Type** to set it as **Point** or **Vector**.
- (3) Select the duration in the duration display box of the **Persist**, including **Close**, **1 Second**, **2 Seconds**, **5 Seconds** and **Infinity**. When the duration is **Infinity**, the recording point is maintained until the control value is changed. Select **Close** to close the afterglow and clear the display.
- (4) Select **Clear** in the menu to erase previously collected results from the display, and the oscilloscope will start cumulative collection again.

Color Grade:

The color temperature display function uses the color level to indicate the frequency of waveform occurrence. Warmer colors such as red/yellow indicate more frequent waveforms, while cooler colors such as blue/green indicate less frequent waveforms.

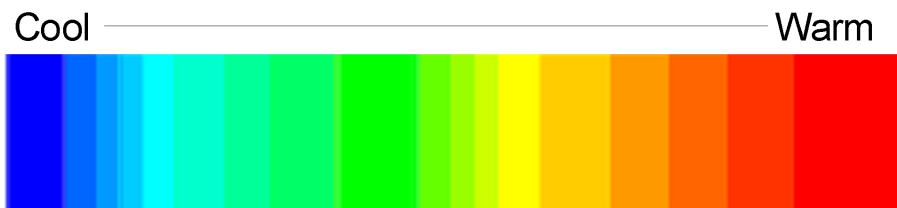

- (1) Click **Display** in the others module in the main setting window at the bottom right of the screen .
- (2) Click **Color Grade** when the switch label is highlighted on the right, it is enabled, click again to close the Color Grade.

Show Scale:

When using the show scale function, measurement is achieved by displaying adjustable reference lines. By adjusting the scale position, users can directly read the numerical values of waveforms on the scale.

- (1) Click **Display** in the others module in the main setting window at the

bottom right of the screen .

- (2) Click **Show Scale** when the switch label is highlighted on the right, it is enabled, the voltage range is displayed on the right side of the grid, and the time base range is displayed at the bottom. Click again to close the Show Scale.

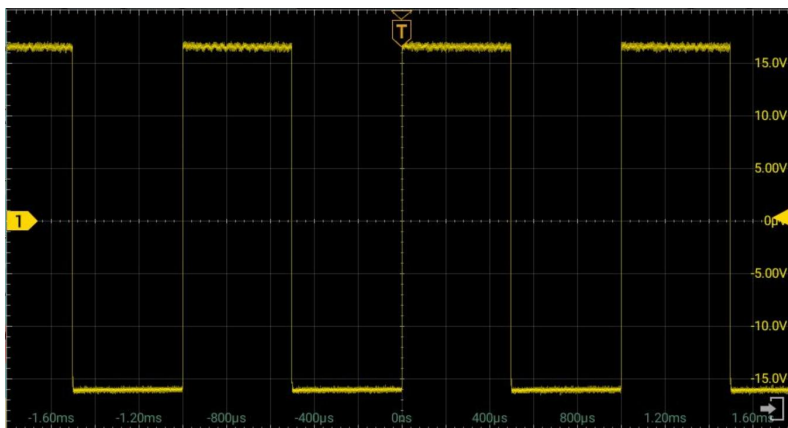

How To Save And Print

User Configuration: Under normal circumstances, if there is no operation for 10 seconds, the configuration will be automatically saved, and the saved state will be restored when the app is opened again.

Click **Save** in the others module in the main setting window at the bottom right of the screen . Save oscilloscope waveform and picture, set to USB or internal memory by operating **Save** in the setting window; operate **Print** to print the image displayed on the oscilloscope screen.

The descriptions of **Save** setting window are as shown in the table below:

Menu	Settings		Descriptions
Save	Type	Wave Image Set	Select the function menu required.
	When the type is Wave , the menu shows as following:		
	Path	Internal External	Select the save path. Save in internal or external USB storage.
	Format	Csv Zip Matlab	Select the waveform save format.
	Source	CH1 CH2 CH3	Select the waveform to be saved, it is available to save CH1 or CH2 or CH3 or CH4 or MATH or DIR or FFT waveforms(When a channel is

5. Use the Oscilloscope

	CH4 MATH DIR FFT	not open, it can not be saved).
Name		Save the wave by editing the file name or the system default file name.
Suffix	Time Series None	Add a times suffix to the filename. Add a series suffix to the filename. The file has no suffix.
Save		Save current waveform.
When the type is Image , the menu shows as following:		
Path	Internal External	Select the save path. Save in internal or external USB storage.
Browse		Click to open the browse screen to save the picture.
Format	Bmp Png Jpg Tif	Select the save format of current screen picture.
Inverse		Enable or disable picture save background; when the color inverse is enabled, use the white background to save the picture.
Time		Open or close the time for printing images. When enabled, the printed image will display the specific printing time of the image in the lower right corner of the image.
Name		Save the image by editing the file name or the system default file name.
Suffix	Time Series None	Add a times suffix to the filename. Add a series suffix to the filename. The file has no suffix.
Save		Save current waveform.
When the type is Set , the menu shows as following:		
Path	Internal External	Select the save path. Save in internal or external USB storage.
Browse		Click to open the saved settings.
Internal	User0 . . . User9	Set storage location.
	Save	Save the current parameter settings of the

			oscilloscope to the internal memory.
		Load	Calls the settings saved at the current storage location.
		Rename	Rename the currently saved parameter. Click on the Rename Input Box and enter the string directly through the alphabet keyboard that pops up.
	External	Name	Save the wave by editing the file name or the system default file name.
		Already configured, click import	Import saved configuration.
		Save	Save the current parameter settings of the oscilloscope to the internal memory.
Print	Inverse		Open or close the save background for the printed image. When inverting color is opening, the image will be printed with a white background.
	Time		Open or close the time for printing images. When enabled, the printed image will display the specific printing time of the image in the lower right corner of the image.
	Area	Full Screen Waveform Area	Sets the type to print the current screen image. Full Screen: Print the full screen image of the oscilloscope; Waveform Area: Print an image of the waveform area on the oscilloscope screen.
	Help		Click and go to the official website to obtain the printer installation package.
	Print		Click and select printer for image printing.

How To Print Screen Images

To print the image displayed on the instrument screen, follow the steps below:

- 1、 Click **Save** in the others module in the main setting window at the bottom right of the screen . Start print operation, as shown in the following picture.

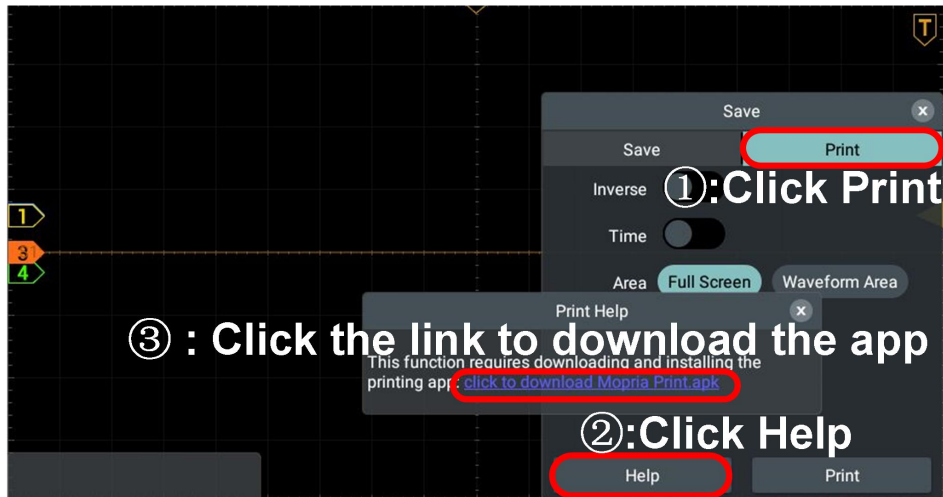

2、 In website install print app, steps as shown in Figure1 to Figure 5.

① Click **Download** to download installation package, as shown in Figure 1.



Figure 1

② Click **Open** to installation package, as shown in Figure 2.

5. Use the Oscilloscope

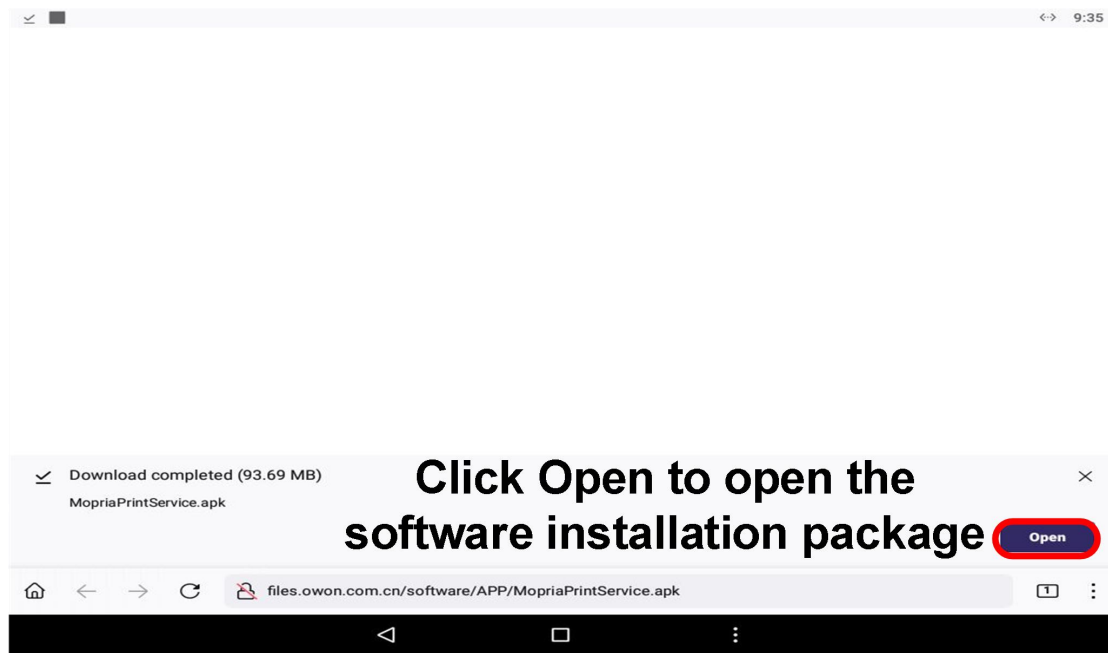

Figure 2

③ Click **INSTALL**, start to install print app, as shown in Figure 3.

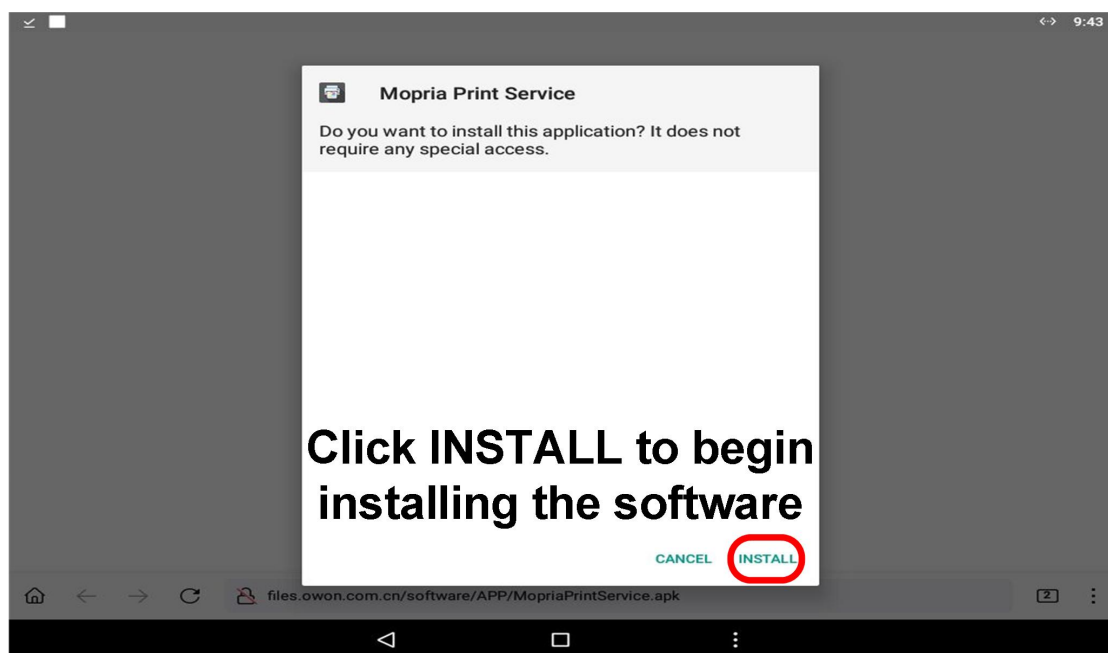

Figure 3

④ Software install produce, as shown in Figure 4.

5. Use the Oscilloscope

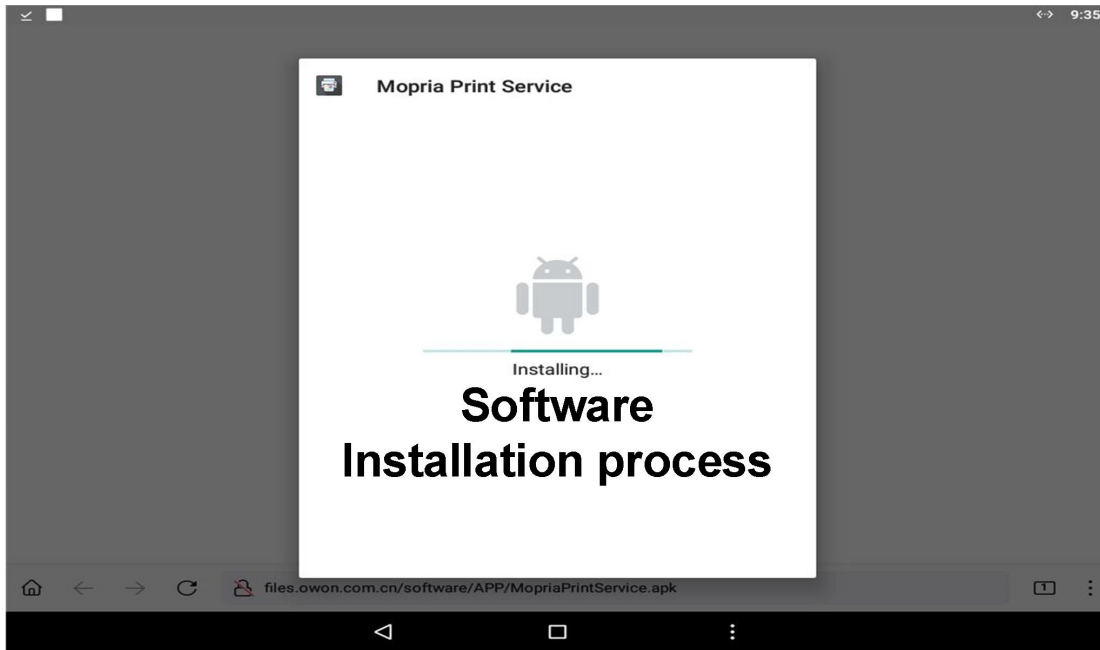

Figure 4

⑤ After install success, click **OPEN** can open print app. As shown in Figure 5.

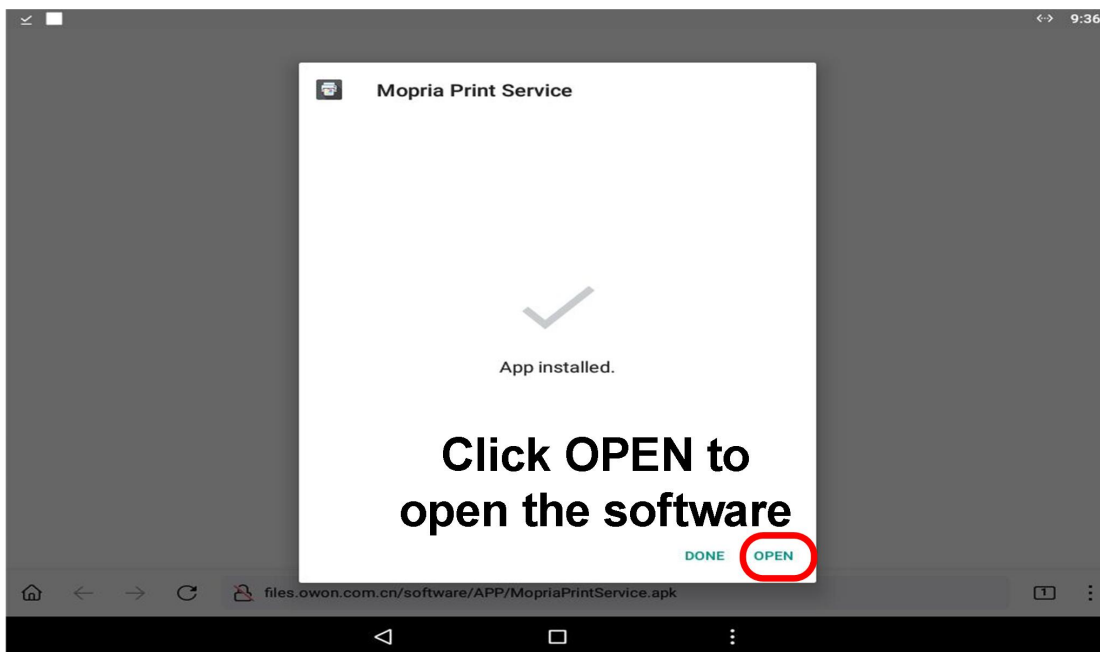

Figure 5

3. Open the installed printing software, as shown in Figure 6. Go to the last page and check "**Agree**" license agreement and privacy policy. Click "**I AGREE**" to start using the software, as shown in Figure 7.

5. Use the Oscilloscope

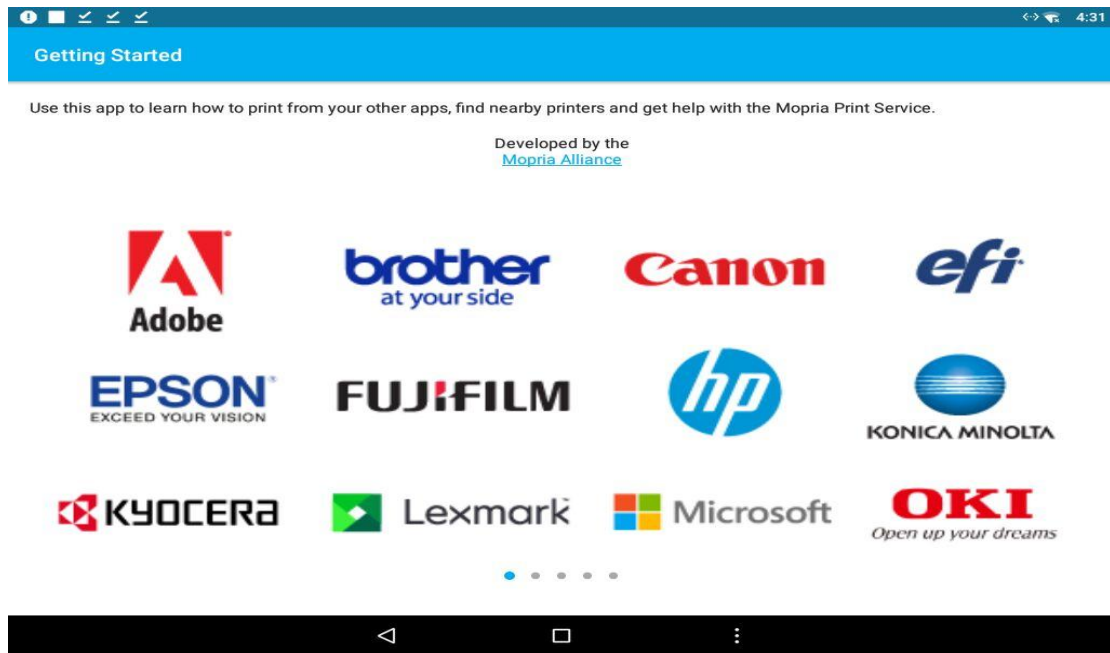

Figure 6

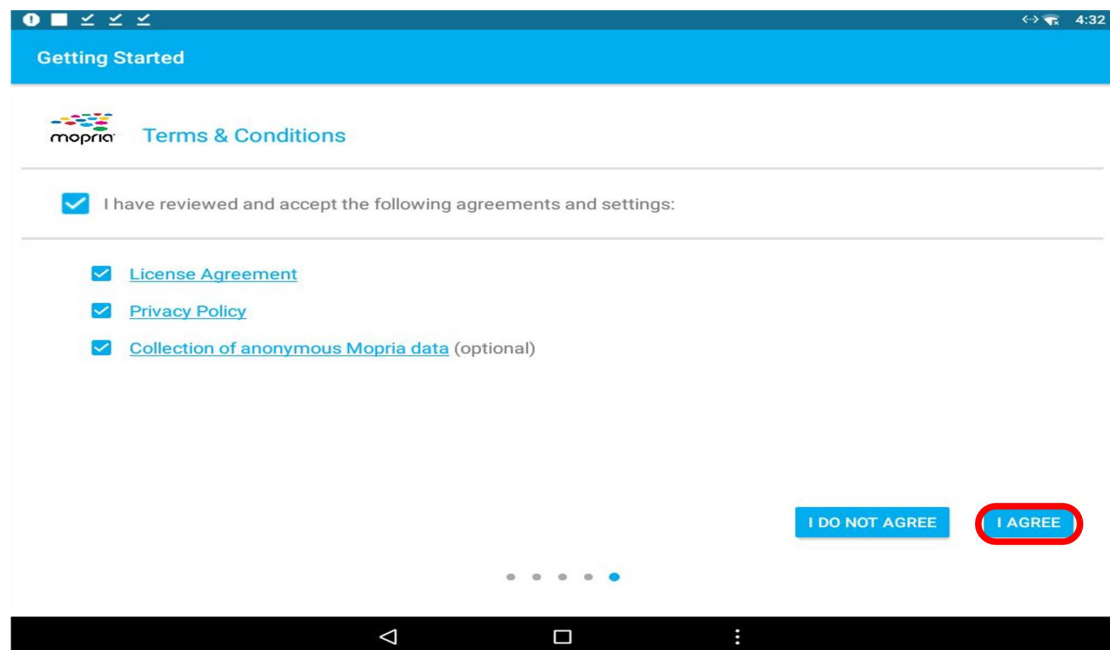

Figure 7

4、 After entering the printing software interface, click "**Enable Wi-Fi to see nearby printers**" to connect the printer's Wi-Fi, as shown in Figure 8. The Wi-Fi connection is successful, as shown in Figure 9.

5. Use the Oscilloscope

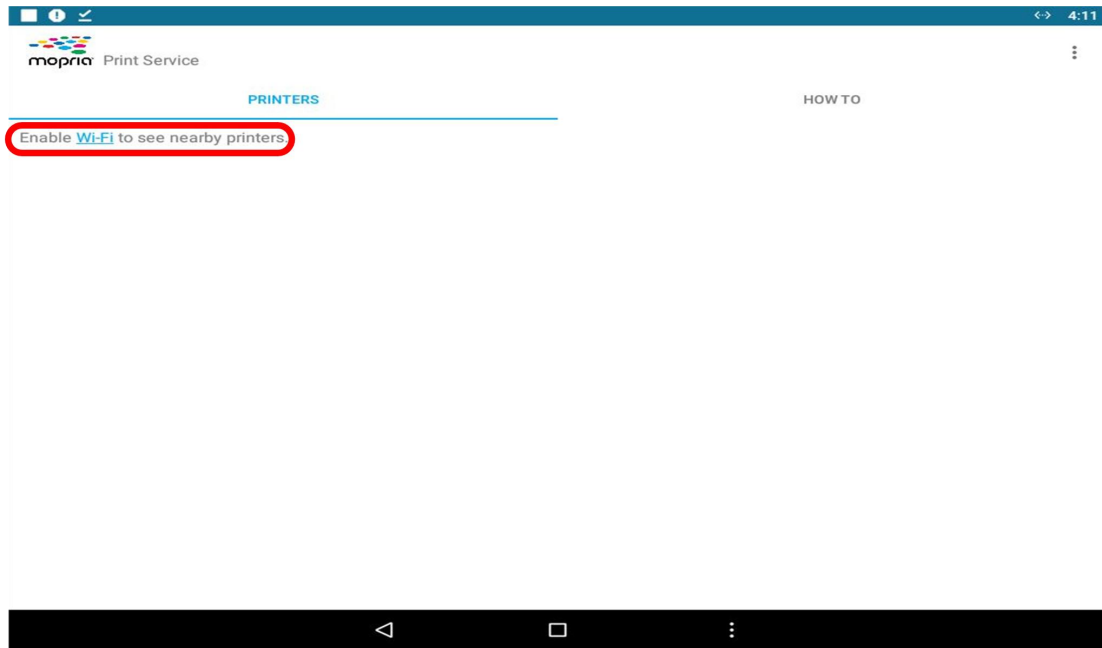

Figure 8

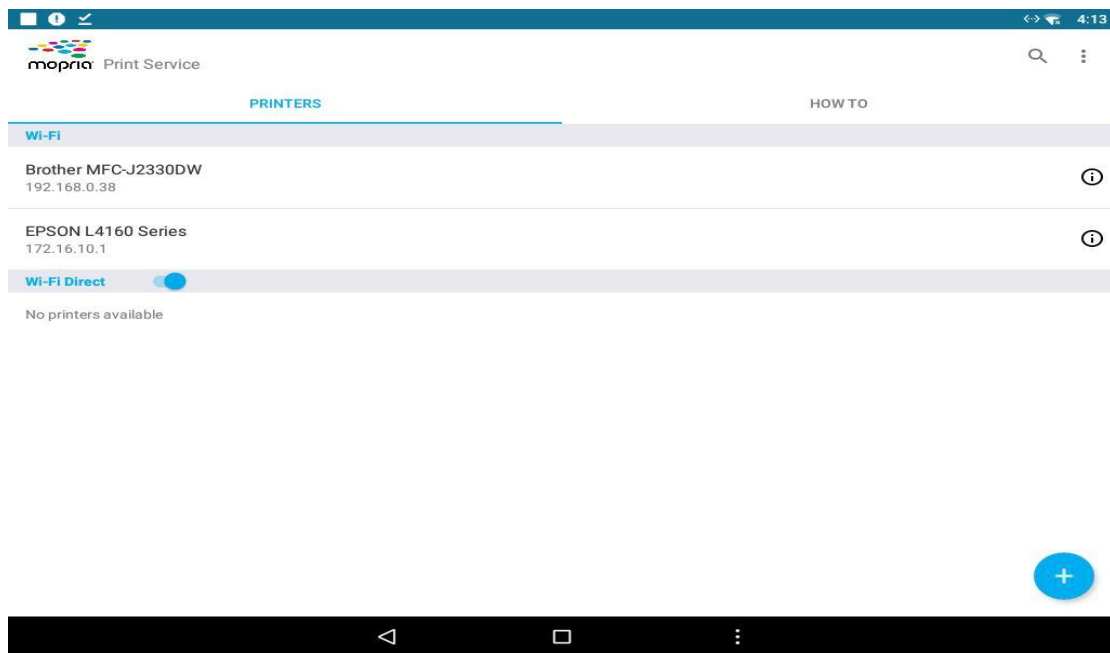
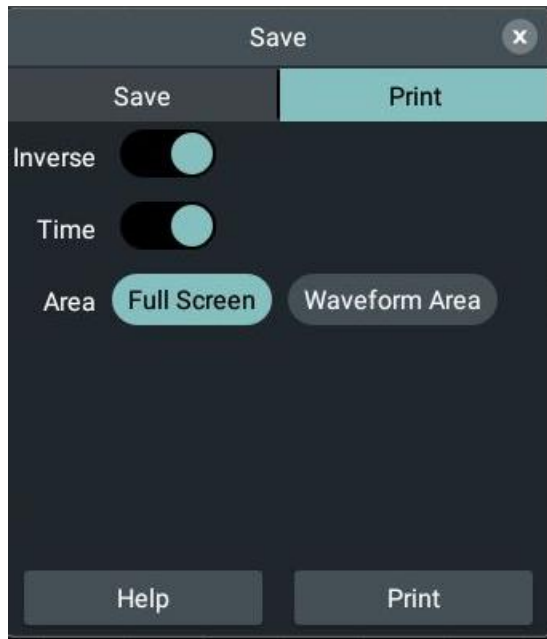

Figure 9

5、 In the menu below, set the printing parameters. Click to open **Inverse** , the image will be printed with a white background. Click to open Time, the image will display specific printing time of the image. Select printing area: **Full Screen** or **Waveform Area**. After setting the parameters, click "Print" to enter the print interface, as shown in the picture below.

5. Use the Oscilloscope



6、 Connect the instrument to the printer,as shown in the following picture.

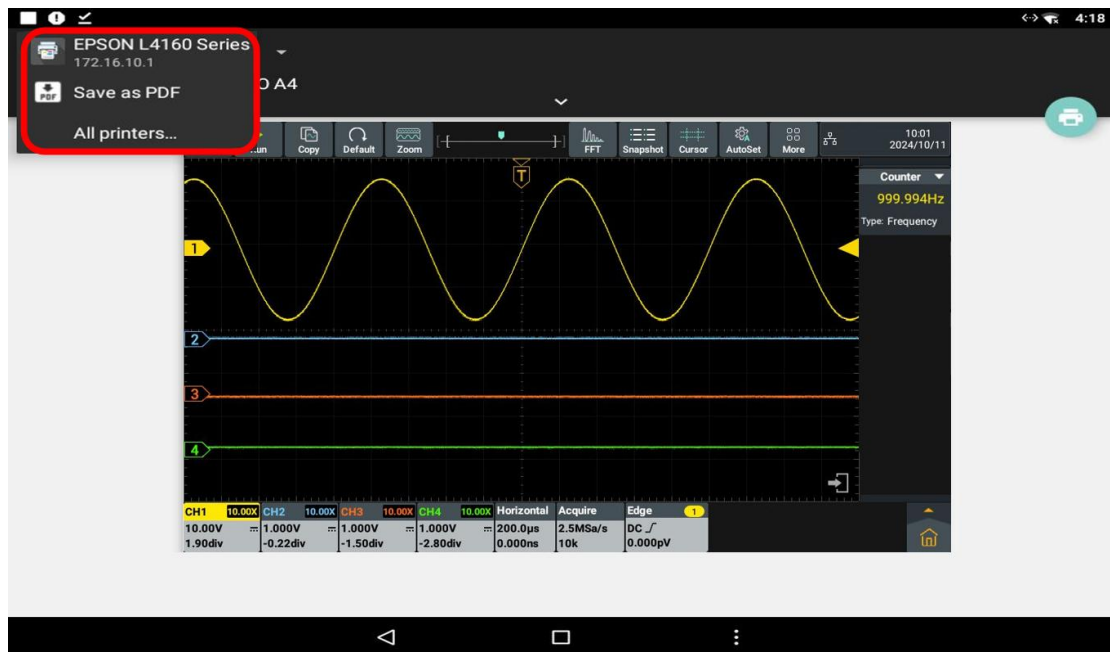

7、 Click  EPSON L4160 Series 172.16.10.1 can set the parameter including: Copies, Paper Size, Color, Orientation, Two-sided and Pages. After setting, click the print icon to print the image, as shown below.

5. Use the Oscilloscope

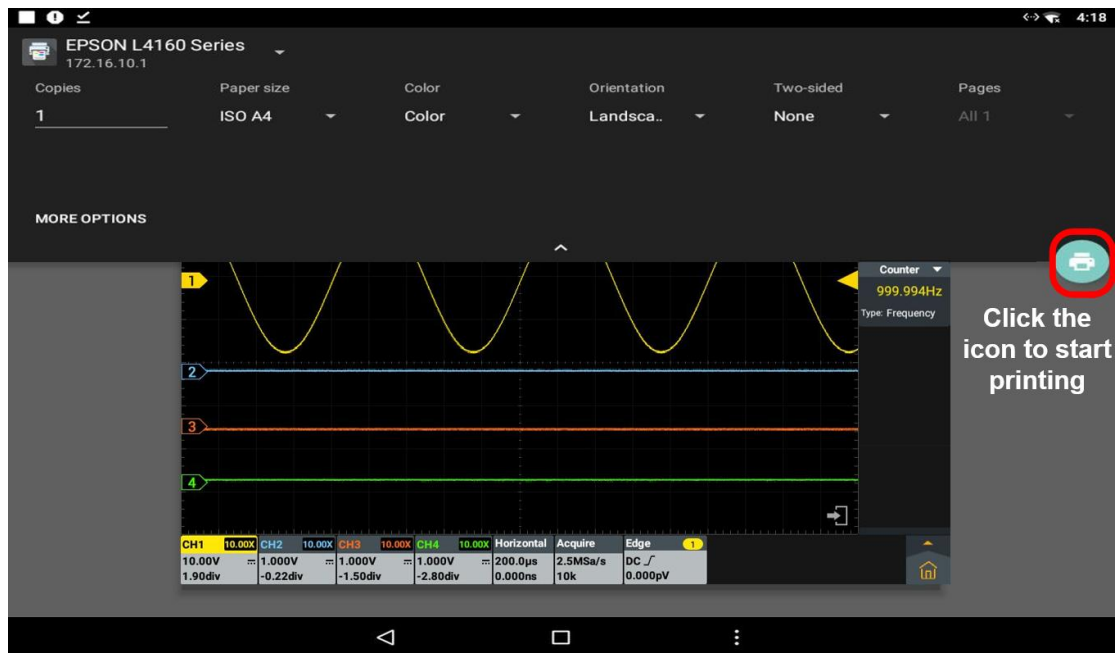

Note:

- Image printing can only be printed over a network connection, USB connection is not valid.
- When printing, turn off borderless printing in More options.
- If WIFI and network cable are connected at the same time, the printer may not be found, do not connect at the same time.

USB Flash Drive Requirements

System-supported USB flash drive format: The file system type is FAT32 and the size of the allocation unit can not exceed 4K. Large-capacity USB flash drive is supported. If the USB flash drive can not be used normally, format it according to the above requirements and try again. There are two ways to format a USB flash drive, namely format by using built-in function of computer system and formatting software (USB flash drive not less than 8G can only be formatted by the second method).

Use system-provided function to format the USB disk

1. Connect the USB disk to the computer.

5. Use the Oscilloscope

2. Right click **Computer**- → **Manage** to enter Computer Management interface.
3. Click Disk Management menu, and information about the USB disk will display on the right side with red mark 1 and 2.

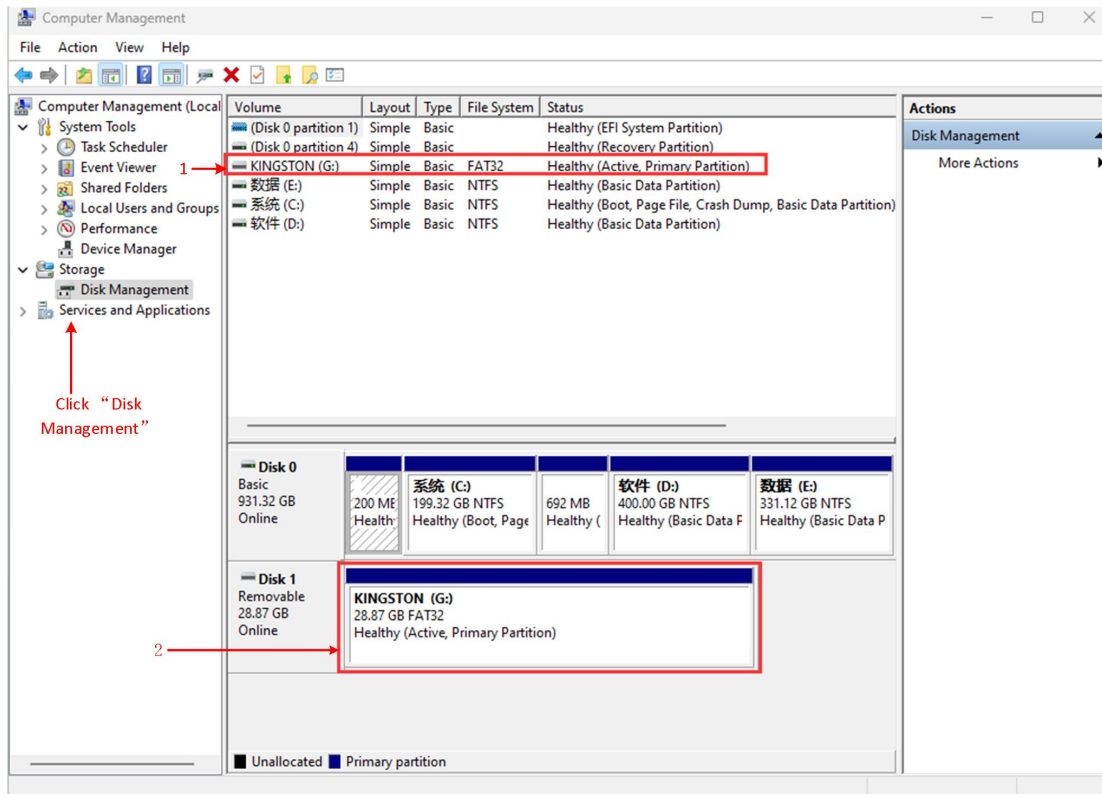

Figure 5-9: Disk Management of computer

4. Right click 1 or 2 red mark area, choose **Format**. And system will pop up a warning message, click **Yes**.

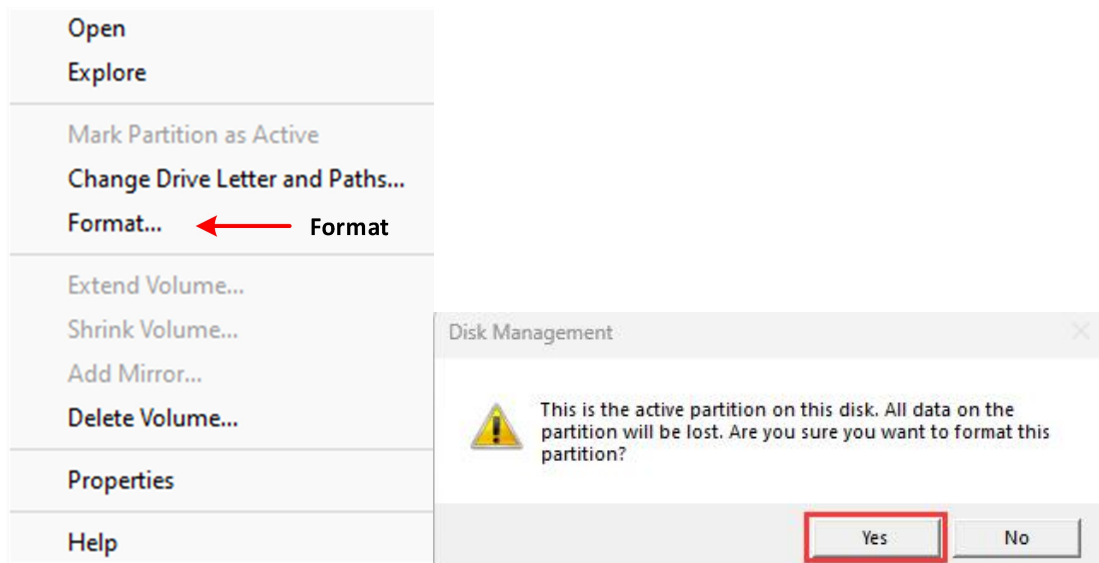

Figure 5- 10: Format the USB disk warning

- Set File System as FAT32, Allocation unit size Default. Check "**Perform a quick format**" to execute a quick format. Click **OK**, and then click **Yes** on the warning message.

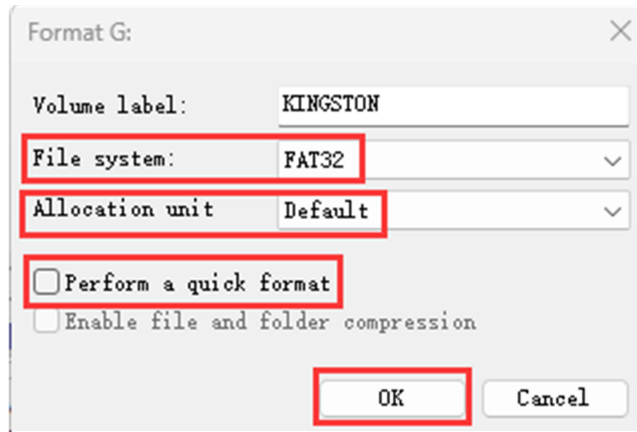

Figure 5- 11: Formatting the USB disk setting

- Formatting process.

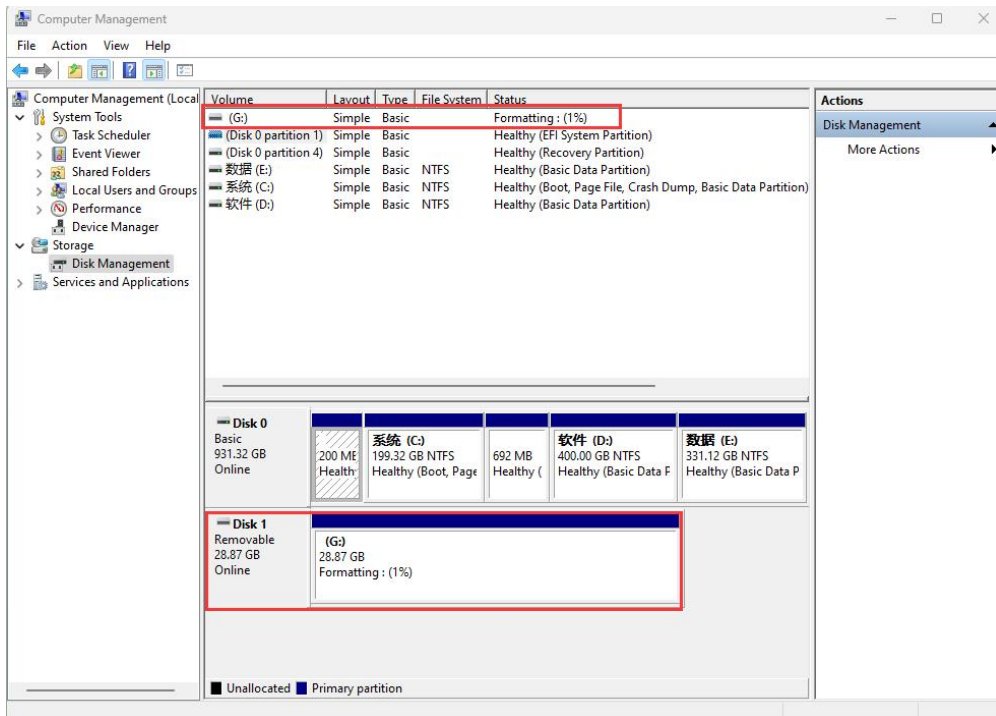

Figure 5- 12: Formatting the USB disk

- Check whether the USB disk is FAT32 with allocation unit size 4096 after formatting.

Use Minitool Partition Wizard to format

Download URL: <http://www.partitionwizard.com/free-partition-manager.html>

Tip: There are many tools for the USB disk formatting on the market, just take Minitool Partition Wizard for example here.

1. Connect the USB disk to the computer.
2. Open the software **Minitool Partition Wizard**.
3. Enter the app interface and information about the USB disk will display on the right side with red mark 1 and 2.

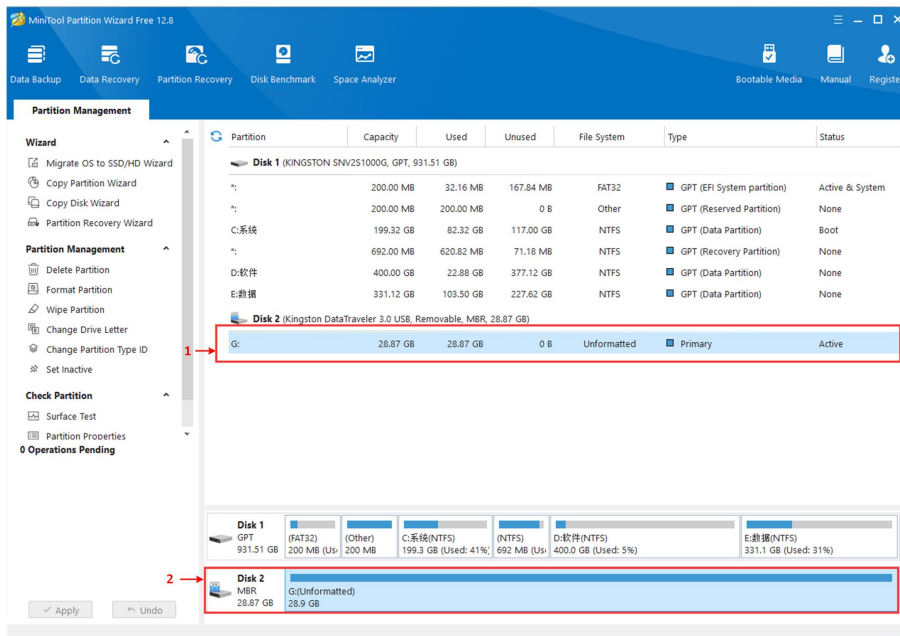

Figure 5- 13:Reload Disk

4. Right click 1 or 2 red mark area, choose **Format**.

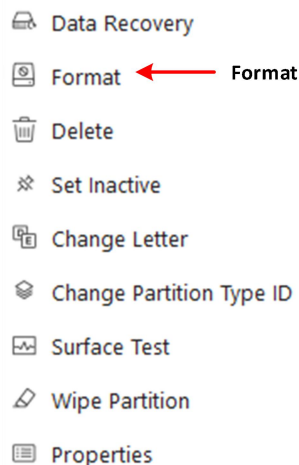

Figure 5- 14: Choose format

5. Set File System FAT32, Cluster size Default. Click **OK**.

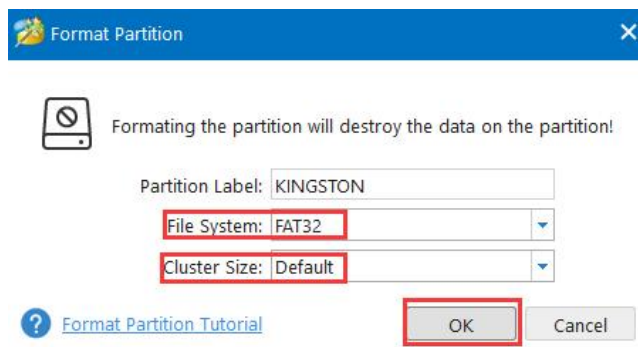

Figure 5- 15:Format setting

6. Click **Apply** at the top left of the menu. Then click **Yes** on the pop-up warning to begin formatting.

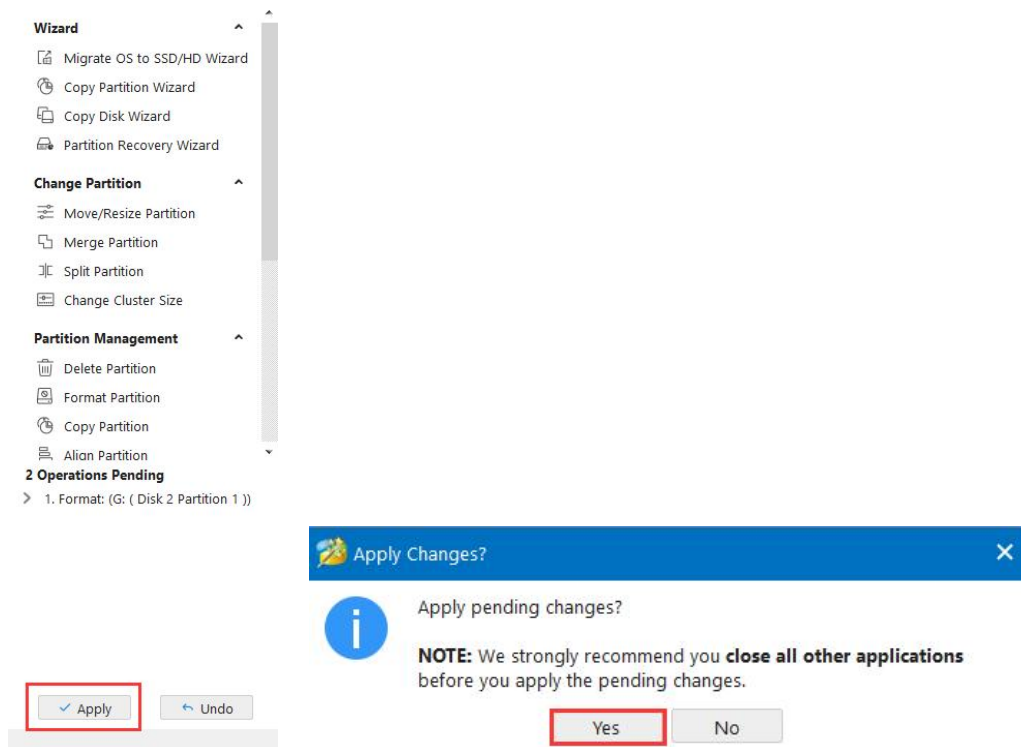

Figure 5- 16:Apply setting

7. Formatting process.



Figure 5- 17:Format process

8. Format the USB disk successfully.

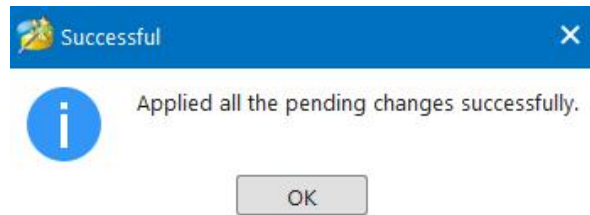

Figure 5- 18: Format successfully

How To Set Reference Waveform

100 reference waveforms can be stored in the instrument, which can be displayed with current waveform simultaneously. The stored waveform can not be adjusted after being called.

The setting window of the reference waveform is shown as follows:

5. Use the Oscilloscope



To store CH1 channel waveform to waveform0, operate according to the following steps:

1. Open CH1 channel.
2. Click **Reference** in the others module in the main setting window at the bottom right of the screen .
3. The setting window will display on the screen. Click **Switch** when the switch label is highlighted on the right, it is enabled.
4. Click 06 waveform6 from the reference waveform list.
5. Click **CH1** in the **Source** to highlight it.
6. Click **Save** and the waveform is saved in the internal memory of the oscilloscope. It is available to customize the waveform name or save it as the waveform6 by default.
7. Click **Display** can display or close the selected reference waveform.

When the switch label is highlighted on the right, it is enabled. There is a  label behind the name of reference waveform selected from the reference waveform list, the selected reference waveform is displayed on the screen and the waveform name and relevant information are displayed at the lower right corner of the reference waveform Information Box.

When the display switch is closed, the  label disappears and the reference waveform displayed on the screen will be hidden accordingly.

8. Click **Label** to select a common type or a Custom type. When you select a common type, you can select 31 types of labels. When you select a Custom type, you can click the input box below to enter the required labels. This function is synchronized to rename the reference waveform name.
9. Click on the value input box of the **Scale** to set the desired value of the stored waveform voltage.
10. Click on the value input box for **Offset** to set the desired vertical position of the memory waveform, click  can quickly return zero.
11. Click **Reset** to reset the voltage scale and vertical position of the reference waveform to the scale and position displayed in the information box.
12. **Reference Waveform information box:** Display the selected reference waveform.



Note: The reference waveform can currently save the waveform in CH1, CH2, CH3, CH4, Math, FFT mode.

How To Conduct Self-Calibration

Self-Calibration operation please refer to “How To Conduct Self-Calibration” on Page 17 for detail.

How To Conduct Probe Check

Click **ProbeCh.** in the others module in the main setting window at the bottom right of the screen . The “Probe Check” prompt box will pop up on the

screen. Click **Start** to perform the probe check.

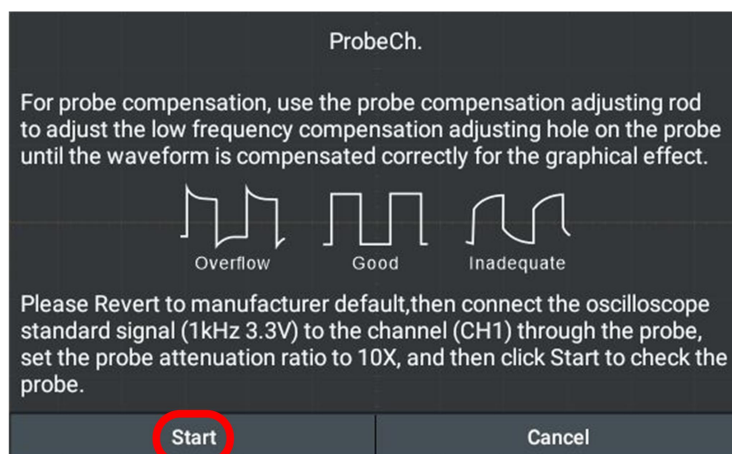

After completing the probe check, the check results are displayed on the screen and click **Quit**. If the result is **undercompensation** or **overcompensation**, please refer to “How to Implement the Probe Compensation” on Page 14 for specific operations.



How To Set Network

Conduct the network settings by using **LAN** interface or **WIFI** module.

- If the **LAN** interface is used, directly insert the network cable into the LAN interface on the back of the instrument to complete the network connection
- If the **WIFI** module is used to connect the network, insert the external WiFi module, press the **Home** key in the Android system area on the front panel, click **Settings** to enter the setting interface, then click **Wi-Fi** switch to enable it, and the network will be connected automatically. If it is the first time to connect to WiFi, click it gain to select the WiFi account, then click the account and enter the WiFi password to connect the network.

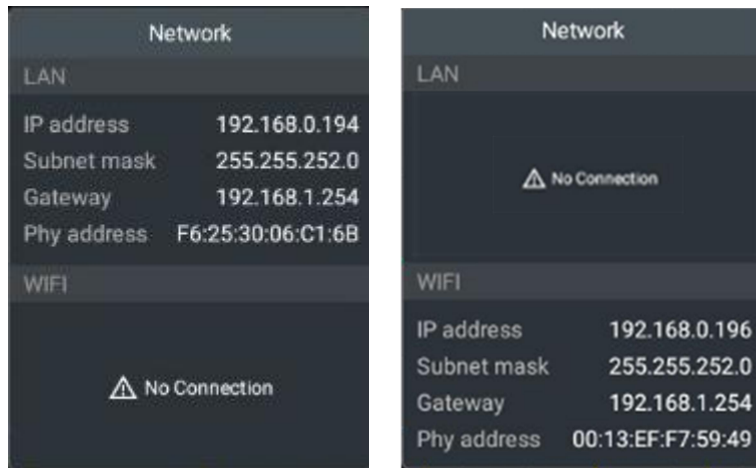

How To Set Up a Network Discovery Service

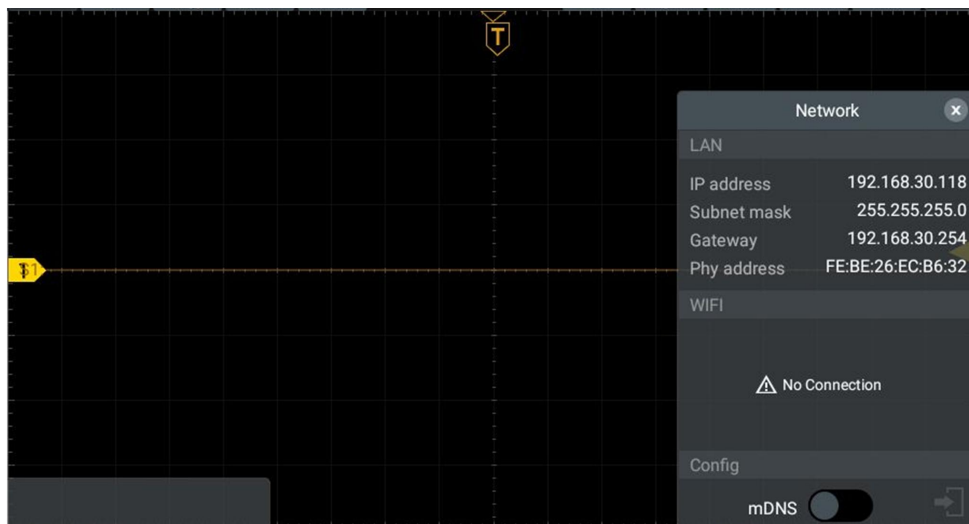

1. Click **Network** in the others module in the main setting window at the bottom right of the screen .
2. Click **mDNS** when the switch label is highlighted on the right, it is enable. LXI software can be used for network discovery services; If this function is disabled, it cannot be used.

Note:After this function is enabled, users can use network services without entering an IP address. (For details, please go to the official website to obtain the "ADS Android Application Manual"). At the same time, users can also integrate mDNS search function through their own secondary development software to query the instrument.

3. Please download your own software with mDNS lookup function. Now the

LXI Discovery Tool software is taken as an example to explain, and the detailed operation is as follows:

- (1) Open LXI app, enter the app interface, as shown in the following picture.

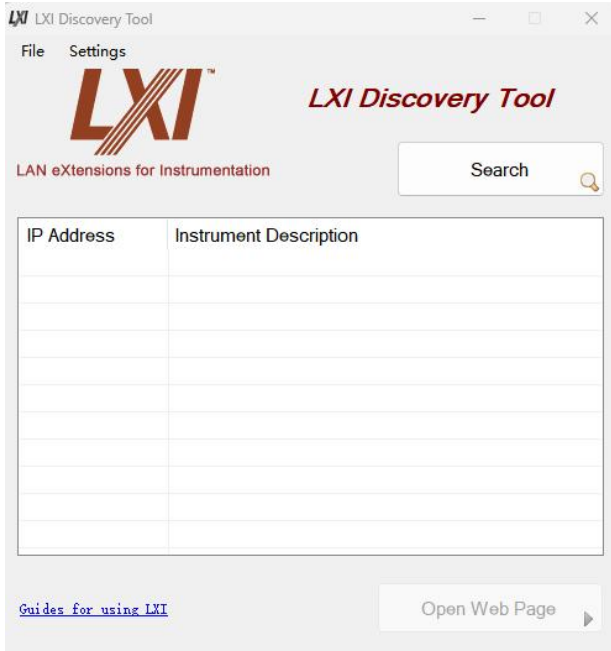

- (2) Click on the **Settings** in the top left corner and select "**Advance View**" as shown below.

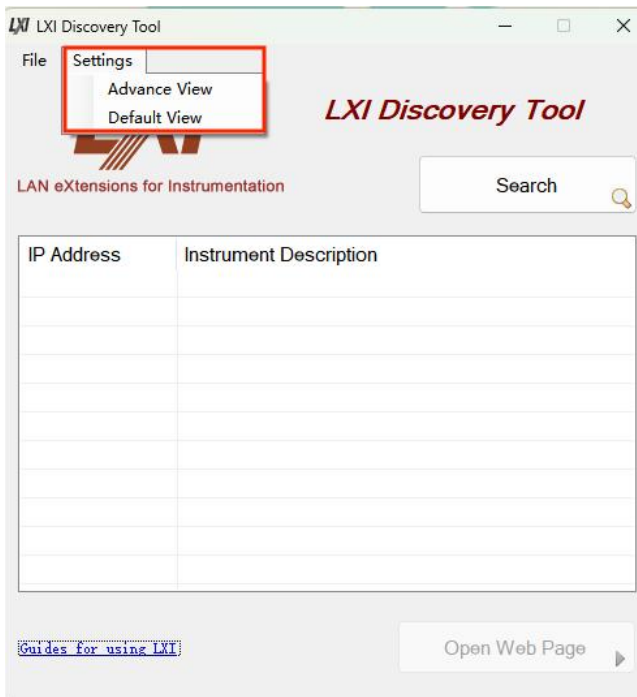

- (3) Enter "**Advance Settings View**" interface, as shown below.

5. Use the Oscilloscope

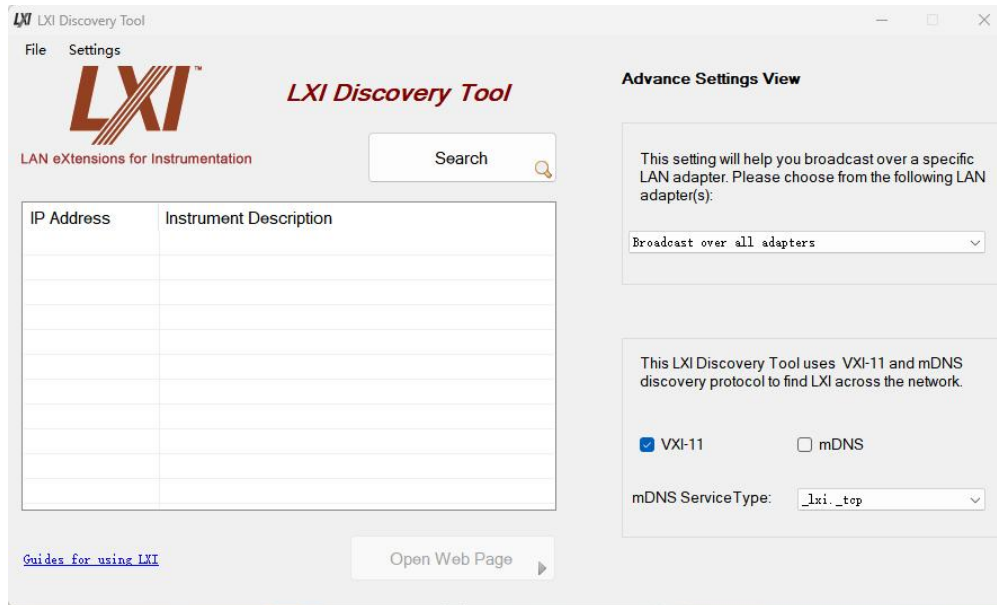

- (4) Under the “**Advance Settings View**” interface, select mDNS, mDNS Service Type select “_http._tcp”, as shown below.

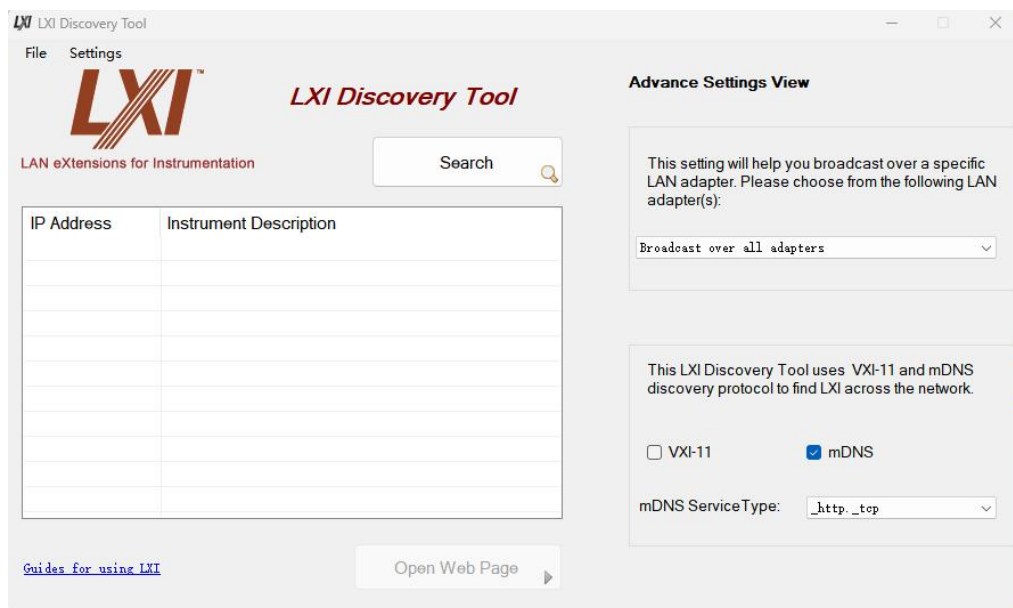

- (5) After setting, click **Search**, available devices can be searched, and the IP address of the device and the corresponding instrument description are displayed, as shown below.

5. Use the Oscilloscope

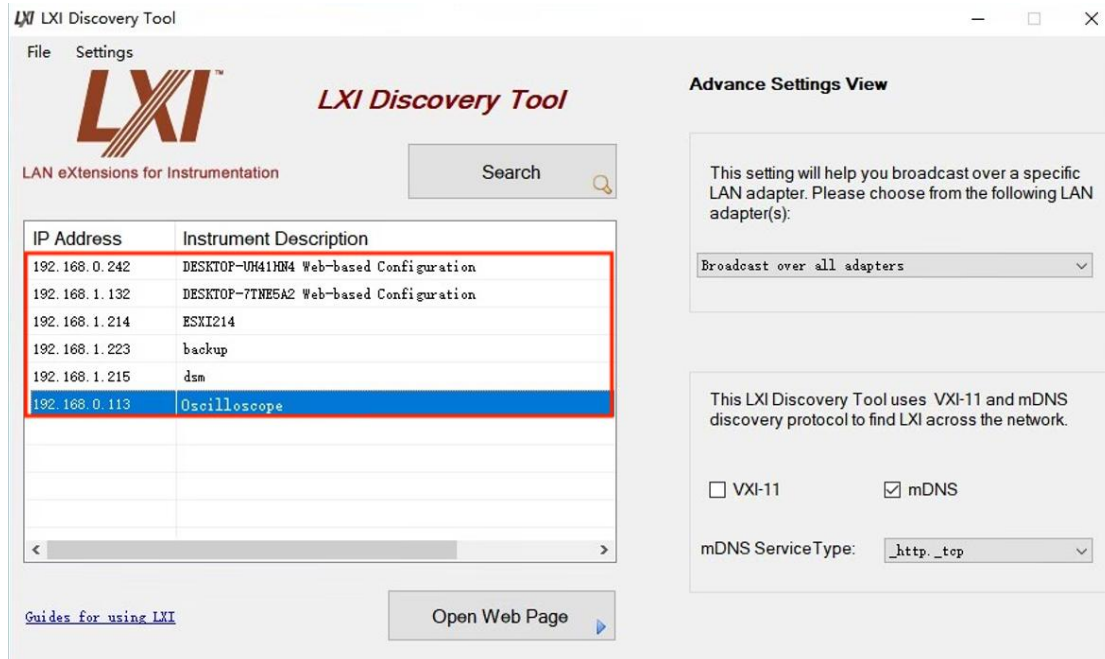

- (6) Select your own instrument, click the corresponding instrument description or click "**Open Web Page**" in the lower right corner to jump to the network service login interface, as shown below.

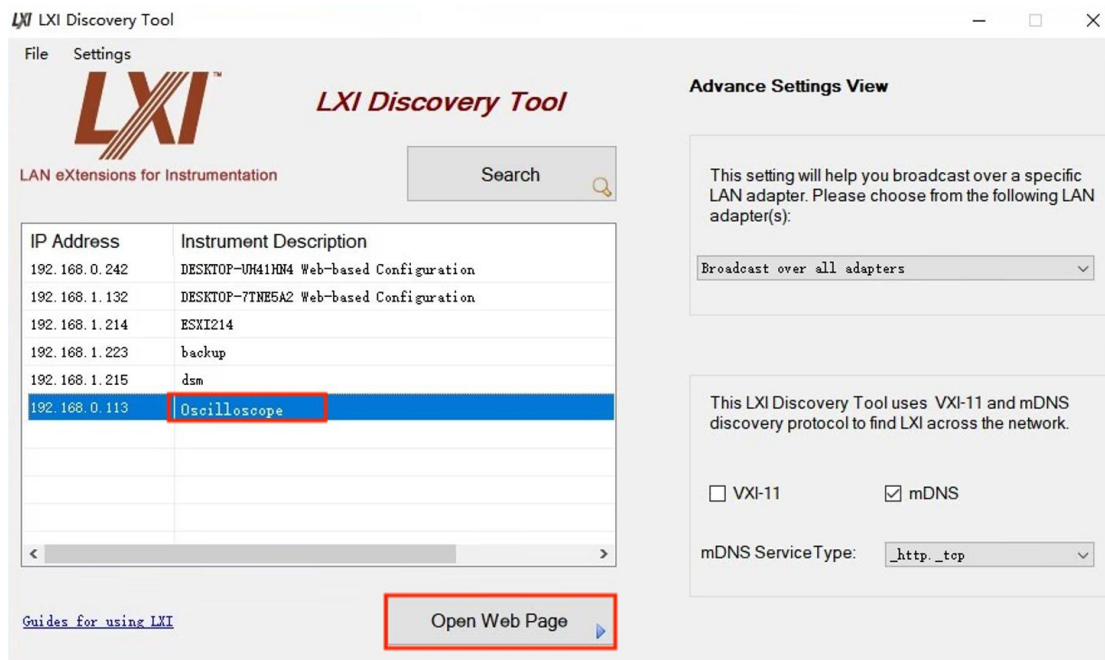

Default

Restore the factory settings. Click **Default** shortcut in the left corner of screen and click **Confirm** in the factory settings window, to restore the factory default state; click **Cancel** if it is not needed.

About

It is composed of About the Application and About the Instrument. The former is to display the latest **version** of the instrument; and the latter is to show the instrument **Product Model**, **Serial Number**, **System Version** and **Checksum**.

Configuration

Click **Config** in the others module in the main setting window at the bottom right of the screen . Set up other auxiliary system functions in the instrument.

Set Language

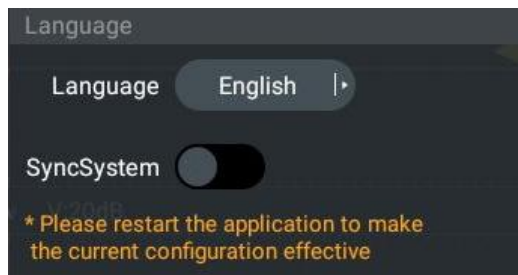

It is mainly used to set the language and choose whether to synchronize with the system.

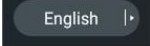
- Click on the right side of the language  to switch languages. In the process of switching languages, you need to click **Confirm** to restart the application for the configuration to take effect.
- If you click **SyncSystem**, when the switch label is highlighted on the right, it is enable, and the language is consistent with the system; If not enabled, the language is the language you set.

Set SyncOutput

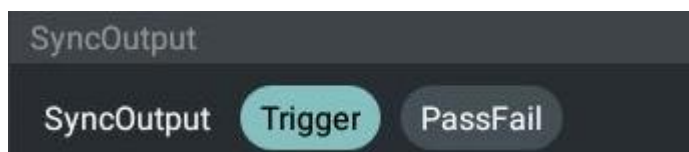

Synchronous output is generally used to synchronize trigger signals or

measurement results with other devices or systems for more accurate and comprehensive measurement, analysis, and control. The output types of the synchronous output of this instrument are trigger output and pass/fail, which can help the user better control and analyze the trigger and validity of the measurement process.

- **Trigger:** The synchronous output trigger signal, that is, the trigger output in the synchronous output allows the instrument to output its internal trigger signal to other devices to control it to start measuring or recording operations;
- **PassFail:** Detects and determines whether the input signal passes the predefined upper and lower limits.

Set Display Format

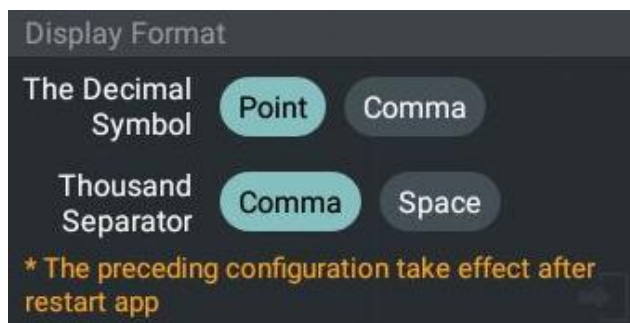

It is mainly used to set the display format of all the values in the instrument.

- Click **The Decimal Symbol** to display the decimal symbol as a **Point** or **Comma**;
- Click **Thousand Separator** to set a **Comma** (**Point**, subject to decimal symbol) or a **Space** between thousand separators.

Note: If the symbol type is different from the current instrument, a prompt box “**restart application to become effective**” will be popped up. Click **Confirm** to restart the application to make the configuration effective.

Foundation Setting

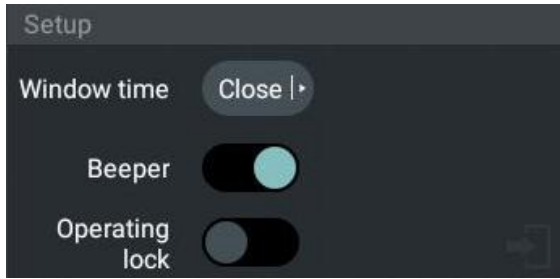

Window time: Set window display time, the value can be set Close, 5s, 10s, 15s, 20s, 25s, 30s. When the set time is up, the setting window will automatically close.

Beeper: Click **Beeper** when the switch label is highlighted on the right, it is enabled. After opening, there will be sound prompts for still and click operations or panel operations.

Operating lock: Click **Operating lock** when the switch label is highlighted on the right, it is enabled. After opening, the touch setting and panel operation are disabled, you need to press the Run/Stop button three times to unlock.

Hardware-Test

Click **Hardware-Test** in the others module in the main setting window at the bottom right of the screen . The function is mainly for the self-inspection of the instrument, including screen detection and key detection, which is used to detect if there is any bright spots or bad spots on the screen, and if there is any wrong key, missing key or reversed key on the instrument.

How To Use Execution Keys

The execution keys include **Run/Stop**, **Autoset** and **Single**.

Automatic Setting:

Set various control values automatically to generate the display waveforms suitable for observation. Press **Autoset** key and the oscilloscope will quickly detect the signal automatically.

The Function Items for Automatic Settings are shown in the table below:

Function Item	Settings
Vertical Coupling	DC(channel coupling remains closed)

Channel switch	Signal open or close (channel switch remains closed)
Vertical Scale	Adjust to the proper scale
Channel Bandwidth	Current
Horizontal Position	Center or two squares to left or right
Horizontal Scale	Adjust to the proper scale
Trigger Type	Rising
Trigger Signal Source	CH1, CH2, CH3 or CH4
Trigger Coupling	DC
Trigger Slope	Current
Trigger Level	At 50% of waveform
Trigger Mode	Auto
Display Mode	YT
Math	Off
FFT	Off
Waveform Amplification	Exit
Pass fail	Current

Autoset judge waveforms type

There are four types: Sine wave or Ramp wave, Square wave or Pulse wave, DC level, unknown source.

The waveform type prompt is displayed on the screen, and the corresponding bottom menu is displayed.

Menu display:

Sine wave or Ramp wave: signal period, multi periods, cancel autoset, auxiliary menu set.

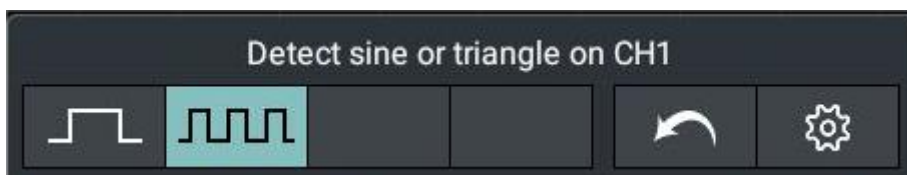

Square wave or Pulse wave: signal period, multi periods, rising edge, falling edge, cancel autoset, auxiliary menu set.

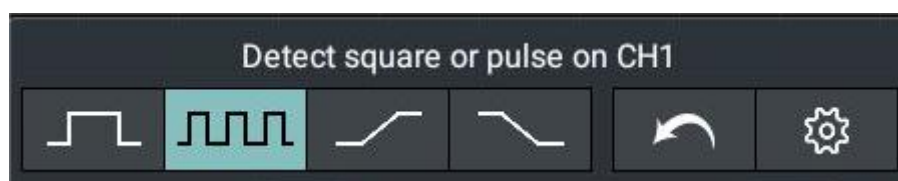

DC level: cancel autose, auxiliary menu set.

Unknown source: cancel autose, auxiliary menu set.



Partial description of nouns:

Signal period: Display 1~2 waveform periods.

Multi periods: Display multiple waveform periods.

Rising edge: Separate shows a rising edge of square wave.

Falling edge: Separate shows a falling edge of square wave.

Cancel autose: Returns information about the last menu and signal.

Auxiliary menu set: Click to enter the auxiliary menu system, including channel switch hold and channel coupling hold.

- Channel switch hold: Select open or close channel switch hold function. If open channel switch hold, perform autose will detect four analog channels CH1, CH2, CH3 or CH4. If doesn't detect channel source, it will close the channel; if detect channel source, it will adjust the best scale to display. If open channel switch hold, no signal channels are closed and perform autose operation only detect opening channel.
- Channel coupling hold: Select open or close channel coupling hold function. If open channel coupling hold function, perform autose operation, channel coupling setting remain unchanged; if close channel coupling hold function, channel coupling default is DC coupling.



Note: If the automatic waveform setting is applied, the frequency and amplitude of the measured signal shall not be less than 20Hz and 5mv,

respectively. If the condition is not met, the automatic waveform setting may be invalid.

Run/Stop: Run and Stop the waveform acquisition.

Note: In the stop state, the vertical gear and horizontal time base of the waveform can be adjusted within a certain range, equivalent to extend the signal in the horizontal or vertical direction. When the horizontal time base is 50ms or less, the horizontal time base can be extended down to 4 scale.

Single: Press this key to directly set the trigger mode as single, which is to acquire a waveform when one trigger is detected and then stop acquisition.

6. Technical Specifications

Unless otherwise stated, all technical specifications apply to digital oscilloscope with the attenuation switch of the probe set to 10X.

- The instrument must be operated continuously for more than thirty minutes under the specified operating temperature.
- If the operating temperature range changes not less than 5°C, it is required to open the system function menu and execute “Self-calibration” program (See “How to conduct self-calibration” in Page 17).

All specifications are guaranteed except those marked with “Typical”.

Oscilloscope

Vertical System

Analog Channel

Characteristics	Instruction	
Input Coupling	DC, AC, Ground	
Input Impedance	1 MΩ±2%, parallel with 20 pF±5 pF	
Probe attenuation coefficient setting	Common	10.00μX, 20.00μX, 50.00μX, 100.00μX, 200.00μX, 500.00μX, 1.00mX, 2.00mX, 5.00mX, 10.00mX, 20.00mX, 50.00mX, 100.00mX, 200.00mX, 500.00mX, 1.00X, 2.00X, 5.00X, 10.00X, 20.00X, 50.00X, 100.00X, 200.00X, 500.00X, 1.00kX, 2.00kX, 5.00kX, 10.00kX, 20.00kX, 50.00kX
	Custom	1.00μX - 1.00MX
Maximum Input Voltage	≤300 Vrms	
Vertical Resolution	12 bits	
Vertical Sensitivity	500 μV/div ~ 10 V/div ^[1]	
Displacement	±2 V (500 μV/div – 200 mV/div) ±80 V (500 mV/div – 10 V/div)	
Analog bandwidth	ADS802A/ADS804A	70 MHz
	ADS812A/ADS814A	100 MHz
	ADS822A/ADS824A	200 MHz

6. Technical Specifications

Single bandwidth	Full bandwidth	
Low Frequency (AC coupling, -3dB)	≥10 Hz (at BNC)	
Rising Time(at BNC, typical)	ADS802A/ADS804A	≤ 5 ns
	ADS812A/ADS814A	≤ 3.5 ns
	ADS822A/ADS824A	≤ 1.75 ns
DC Gain Accuracy	≤1 mV	3%
	2 mV	2%
	≥5 mV	1.5%
DC accuracy (average)	Delta Volts between any two averages of ≥16 waveforms acquired with the same scope setup and ambient conditions (ΔV): $\pm(2\% \text{ rdg} + 0.05 \text{ div})$	
Channel–channel isolation	50 Hz: 100:1 10 MHz: 40:1	
Time delay between channel(typical)	150 ps	
Waveform inverted	Support	
Bandwidth limit	20 MHz, full bandwidth	

Description:

[1]: 200 $\mu\text{V}/\text{div}$, 500 $\mu\text{V}/\text{div}$ is a digital magnification of 1mV/div.

Horizontal System

Analog Channel

Characteristics	Instruction
Scanning speed (s/div)	1 ns/div - 1000s/div, step by 1-2-5
Time base accuracy	$\pm 25 \text{ ppm}$ (typical value, ambient temperature: +25°C)
Time interval (ΔT) measurement accuracy(DC ~ 100MHz)	Single: $\pm(1 \text{ interval time} + \text{time base accuracy} \times \text{reading} + 0.2 \text{ ns})$ Average > 16: $\pm(1 \text{ interval time} + \text{time base accuracy} \times \text{reading} + 0.1 \text{ ns})$
Sampling rate range	0.05 Sa/s ~ 2.5 GSa/s
Maximum Storage Depth	50M

Acquire System

Characteristics	Instruction	
Acquire mode	Sample, Peak, High Res, Average, Segmentation	
Maximum real-time acquire rate	Four Channel, Dual Channel ^[1]	625 MSa/s
	Dual Channel ^[2]	1.25 GSa/s
	Single Channel	1.25 GSa/s
Waveform capture rate	Real-time acquire: 50,000 wfms/s Segment acquire: 700,000 wfms/s	
Record length	1k, 10k, 100k, 1M, 10M, 25M, 50M	
	Note: The record length is dynamic, changing with the number of channel openings and acquire mode.	
Interpolation	Auto, Sinx/x, x	
Segmentation	Maximum of 250,000 segments that can be acquired.	

Description:

[1]: Limited to four-channel models, the maximum real-time sampling rate of dual channels must be one of the following conditions: CH1 and CH2 are both on, or CH3 and CH4 are both on.

[2]: Limited to four-channel models, the maximum real-time sampling rate of two channels should meet one of the following conditions: only one channel of CH1 and CH2 can be turned on, and only one channel of CH3 and CH4 can be turned on.

Trigger

Trigger System

Characteristics	Instruction
Trigger source	CH1, CH2, CH3, CH4
Trigger mode	Auto, Normal, Single
Trigger type	Edge trigger, Video trigger, Pulse trigger, Slope trigger, Runt trigger, Windows trigger, Timeout trigger, Nth trigger, Logic trigger, RS232/UART trigger, I2C trigger, SPI trigger, CAN trigger, LIN trigger
50% level setting (typical)	Input signal frequency \geq 50 Hz
Trigger displacement	According to Record length and time base

6. Technical Specifications

Holdoff range	100 ns to 10s	
Trigger sensitivity	0.3 div ~ 10 div	
Trigger level range	Internal	±4 divs from the center of the screen

Trigger Type

Characteristics	Instruction	
Edge Trigger	Couple	DC, AC, HF
	Slope	Rising, Falling
Video Trigger	Modulation	Support standard NTSC, PAL and SECAM broadcast systems
	Line number range	1-525 (NTSC) and 1-625 (PAL/SECAM)
Pulse Trigger	Trigger condition	Positive pulse: >, <, = Negative pulse: >, <, =
	Pulse Width range	30 ns to 10 s
Slope Trigger	Trigger condition	Positive pulse: >, <, = Negative pulse: >, <, =
	Time setting	30 ns to 10 s
Runt Trigger	Trigger condition	Positive pulse: >, <, = Negative pulse: >, <, =
	Time setting	30 ns to 10 s
Windows Trigger	Trigger condition	Positive pulse: superamplitude entry, superamplitude exit, and superamplitude time Negative pulse: superamplitude entry, superamplitude exit, and superamplitude time
	Time setting	30 ns ~ 10 s
Timeout Trigger	Slope	Rising, Falling
	Idle Time	30 ns ~ 10 s
The Nth Edge Trigger	Slope	Rising, Falling
	Idle Time	30 ns ~ 10 s
	Edge Number	1 ~ 128
Logic trigger	Logic Mode	AND, OR, XOR, XNOR
	Input Mode	H, L, X, Rising, Falling
	Output Mode	Goes True, Goes False, Is True >, Is True <, Is True =
RS232/UART Trigger	Polarity	Normal, Inverted
	Trigger Condition	Start, Error, Chk Error, Data
	Baud Rate	Common, Custom

6. Technical Specifications

	Data Bits	5 bits, 6 bits, 7 bits, 8 bits
I2C Trigger	Trigger Condition	Start, Restart, Stop, Ack Lost, Addr, Data, Addr/Data
	Address Range /Byte Length	7 bits---->0 to 127 8 bits---->0 to 255 10 bits--->0 to 1023
	ByteLength	1 to 5
SPI Trigger	Trigger Condition	Timeout, CS
	Timeout value	30 ns to 10s
	Data Bits	4 bits to 32 bits
	Edge	Rising, Falling
CAN Trigger	Signal Type	CAN_H, CAN_L, TX, RX, DIFF
	Trigger Condition	Start, Type, Data, ID, ID/Data, End, Lost, Error
	Baud Rate	Common, Custom
	Sample Point	0.5% to 95%
	Frame Type	Data, Remote, Error, Overload
LIN Trigger	Condition	Break, ID, ID/Data, Data Error
	Baud Rate	Common, Custom

Waveform

Waveform Measurement

Characteristics	Instruction	
Cursor Measurement	ΔV , ΔT , $\Delta T \& \Delta V$ between cursors, auto cursor, support XY/FFT/ZOOM window, based on screen percentage	
	Number	2 pairs of XY cursors
	Manual mode	ΔV , ΔT
	Tracing mode	The voltage value and time value of the X waveform point are tracked by fixing the Y axis The fixed X-axis tracks the voltage value and time value of the Y waveform point
	Auto measurement cursor	Allows the cursor to be displayed during automatic measurements
	XY Mode	The voltage parameters of the corresponding channel waveforms were measured in XY timebase mode X= Channel 1, Y= Channel 2

6. Technical Specifications

Auto measurement	Number	43 automatic measurements with up to 8 measurements displayed simultaneously
	Measurement source	CH1 - CH4
	Measurement area	Primary time base, extended time base, cursor area
	Vertical	Period, + Width, Rise Time, +Duty, Frequency, - Width, Fall Time, -Duty and ScrDuty
	Horizontal	Vavg, Vpp, Vamp, StdDev, Vmax, Vtop, VRMS, Overshoot, Vmin, Vbase, CycRms and Preshoot
	Blend	+PulseCnt, -PulseCnt, RiseCnt, FallCnt, Area and CycArea
	Channel	Delay(1 Φ -2 Φ), Delay(1 Φ -2 Ψ), Delay(1 Ψ -2 Φ), Delay(1 Ψ -2 Ψ), Phase(1 Φ -2 Φ), Phase(1 Φ -2 Ψ), Phase(1 Ψ -2 Φ), Phase(1 Ψ -2 Ψ), FRR(1 Φ -2 Φ), FRF(1 Φ -2 Ψ), FFR(1 Ψ -2 Φ), FFF(1 Ψ -2 Ψ), LRR(1 Φ -2 Φ), LRF(1 Φ -2 Ψ), LFR(1 Ψ -2 Φ) and LFF(1 Ψ -2 Ψ)
Mathematical operation	+, -, *, /, &&, , ^, !, Tan, Intg, Diff, Sqrt, Lg, Ln, Exp, Abs, Sine, CoSin, User Defined Function, digital filter (low pass, high pass, band pass, band reject), FFT(Vrms, dBVrms, Radians, Degrees)	

Waveform Analysis

Characteristics	Instruction	
Pass Fail	The signal under test is compared with a user-defined rule (template), providing the number of passes, failures, and the total number of tests. Pass/fail events can trigger immediate stop, buzzer, and screenshot.	
	Source	CH1 - CH4
	Type	Horizontal, vertical and other measurement items
	Measurement	Data statistics: Pass, Fail and the total number
	Acquire mode	All modes are supported except Zoom, XY, FFT and scroll
Color Grade	Provide three view of waveform intensity, color temperature level >16, 256 color scale display	
	Source	CH1 - CH4

	Waveform brightness	brightness
	Acquire mode	Only basic waveforms are supported
Record	The measured signal is segmented and stored according to trigger events. Specifically, when each trigger event occurs, all captured waveform data is saved as a segment in volatile memory, with a maximum of 125,000 frames that can be acquired.	
	Source	CH1 - CH4
	Analysis	Supports frame-by-frame or continuous playback, and allows for calculation, measurement, and decoding of the played waveforms.

Decode

Characteristics	Instruction
Decode Number	2, Both protocol types can be decoded and switched simultaneously
Decode Type	RS232/UART, I2C, SPI, LIN, CAN
RS232/UART	Decode RS232/UART bus TX/RX signals at speeds up to 10 Mb/s (5 to 8 bits), supporting parity bit (odd parity, even parity, or no parity) and stop bit (1 to 2 bits) configuration. Source Channel: CH1~CH4
I2C	Decode the I2C bus addresses (including or excluding the read/write bit), data, and ACK. Source Channel: CH1~CH4
SPI	Decode SPI bus MISO/MOSI data (4 to 32 bits). The mode supports timeout and chip select (CS). Source Channel: CH1~CH4
CAN	Decode remote frames of the CAN bus at speeds up to 1 Mb/s (ID, byte count, CRC), as well as overload frames and data frames (standard/extended ID, control field, data field, CRC, ACK). Supported CAN bus signal types include CAN_H, CAN_L, TX, RX and DIFF. Source Channel: CH1~CH4
LIN	Decode LIN bus versions 1.X or 2.X, with speeds up to 10 kb/s. Decode and display synchronization, identifier, data, and checksum. Source Channel: CH1~CH4

Counter

Characteristics	Instruction
Source	CH1, CH2, CH3, CH4, Follow trigger
Measurement type	Frequency, period
Statistic parameter	Type, Max, Min, Avg
Maximum frequency	Maximum analog bandwidth
Resolution	6 bits

DVM

Characteristics	Instruction
Source	CH1, CH2, CH3, CH4
Function	AC RMS, DC, AC+DC RMS
Resolution	4 bits
Limit warnings	Support upper and lower limit setting, over-limit condition setting, over-limit prompt

Command

Characteristics	Instruction
Common support	Supports the standard SCPI command set
Error message Definition	Error Message
Support status reporting mechanism	Status Reporting
Support for synchronization mechanisms	Synchronization

General Technical Specification

Display

Characteristic	Instruction
Display Type	7 inch Colored LCD (Liquid Crystal Display)

6. Technical Specifications

Display Resolution	1024 (Horizontal) × 600 (Vertical) Pixels
Display Colors	24 colors, TFT
Grid	18 horizontal cells * 8 vertical cells
Afterglow	Off, infinity, adjustable time (1 second, 2 seconds, 5 seconds)
Brightness level	256 levels

Processor system

Characteristic	Instruction
System memory	2GB RAM
Operating system	Android
Internal non-volatile	8GB

Output of the Probe Compensator

Characteristics	Instruction
Output voltage(typical)	About 3.3 V, with the Peak-to-Peak voltage $\geq 1M \Omega$
Frequency(typical)	1 kHz Square

Others

Characteristics	Instruction
Communication Interface	HDMI; USB device *1, USB Host *1 ; Trig Out(P/F); LAN interface
Power Supply	Type-C power supply interface ^[1] ; DC:12V 4A
Battery	11.1V, 5000mAh (optional) battery is fully charged, it can provide power for approximately 2 hours.
Power Consumption	$\leq 48W$
Touch Screen	Multi-touch Capacitive screen

Description:

[1]: Without generator:the adapter is required to support a handshake protocol of 12V/ $\geq 3A$.

Environment

Characteristics	Instruction
Temperature	Working temperature: 0°C ~ 40°C Storage temperature: -20°C ~ +60°C
Relative humidity	≤90%
Height	Operating: 3,000 m Non-operating: 15,000 m
Cooling Method	Fan cooling

Mechanical Specifications

Characteristics	Instruction
Dimension	260 mm(L)*160 mm(H)*78 mm(W)
Weight	Approx. 1.5kg (without battery) Approx. 1.7kg (with battery)

Interval Period of Adjustment:

One year is recommended for the calibration interval period.

7.Appendix

Appendix A: Accessories

(The accessories subject to final delivery.)

Standard Accessories:



Power Cord



Quick Guide



USB Cable



Probe



Power Supply
Adaptor

Optional Accessories:



BNC to alligator
clip cable

Appendix B: General Care And Cleaning

General Care

Do not store or leave the instrument where the liquid crystal display will be exposed to direct sunlight for long periods of time.

Caution: To avoid any damage to the instrument or probe, do not exposed it to any sprays, liquids, or solvents.

Cleaning

Inspect the instrument and probes as often as operating conditions require.

To clean the instrument exterior, perform the following steps:

1. Wipe the dust from the instrument and probe surface with a soft cloth. Do not make any scuffing on the transparent LCD protection screen when clean the LCD screen.

2. Disconnect power before cleaning your Oscilloscope. Clean the instrument with a wet soft cloth not dripping water. It is recommended to scrub with soft detergent or fresh water. To avoid damage to the instrument or probe, do not use any corrosive chemical cleaning agent.



Warning: Before power on again for operation, it is required to confirm that the instrument has already been dried completely, avoiding any electrical short circuit or bodily injury resulting from the moisture.
